

CHEVROLET 



2023  
**BLAZER**

# Look your best no matter the occasion.

The 2023 Blazer is the SUV that's well-built, roomy and always in good taste. You'll turn heads thanks to its strong stance, updated grille and front fascia, and five new wheel designs. Choose from four models, including the well-equipped 2LT and 3LT, the sport-tuned RS and the sophisticated Premier. Inside, a roomy, driver-centric interior includes up to 64.2 cubic feet<sup>1</sup> of maximum cargo space with the rear seats folded down. Even the second-row seats recline, while sliding forward or backward for more flexibility. Two engine choices provide effortless performance: a turbocharged 2.0L engine or a 308-horsepower V6. Peace of mind is added with standard Chevy Safety Assist,<sup>2</sup> a package of six driver assistance features.

Blazer lets you be your best.



Blazer RS in Radiant Red Tintcoat (extra-cost color) with available features.

<sup>1</sup> Cargo and load capacity limited by weight and distribution. <sup>2</sup> Chevy Safety Assist includes Automatic Emergency Braking, Front Pedestrian Braking, Lane Keep Assist with Lane Departure Warning, Forward Collision Alert, IntelliBeam and Following Distance Indicator. Safety or driver assistance features are no substitute for the driver's responsibility to operate the vehicle in a safe manner. Read the vehicle Owner's Manual for important feature limitations and information.



## At a glance.

- Sleek and athletic 5-passenger midsize SUV
- Well-appointed driver-centric interior
- Four models: 2LT, 3LT, RS and Premier
- Chevy Safety Assist,<sup>1</sup> standard on all models, includes
  - Automatic Emergency Braking
  - Front Pedestrian Braking
  - Lane Keep Assist with Lane Departure Warning
  - Forward Collision Alert
  - IntelliBeam,<sup>®</sup> auto high beams
  - Following Distance Indicator
- 2.0L Turbo or 3.6L V6 engine paired with a 9-speed automatic transmission
- 4,500 lbs. of maximum towing capability<sup>2</sup>
- Remote vehicle starter system
- Up to 64.2 cubic feet of maximum cargo space<sup>3</sup> with rear seats folded down
- Reclining second-row seats also slide forward or rearward
- Wireless Apple CarPlay<sup>®4</sup> and wireless Android Auto<sup>™5</sup> compatibility
- Two-tone roof available on 2LT, 3LT and RS
- Available all-wheel drive
- Midnight/Sport Edition and Redline Edition available on 2LT and 3LT



Blazer RS in Radiant Red Tintcoat (extra-cost color) with available features.



Blazer RS interior in Jet Black with Red accents and available features.

<sup>1</sup> Safety or driver assistance features are no substitute for the driver's responsibility to operate the vehicle in a safe manner. Read the vehicle Owner's Manual for important feature limitations and information. <sup>2</sup> With available 3.6L V6 engine and trailering equipment. Maximum trailering ratings are intended for comparison purposes only. Before you buy a vehicle or use it for trailering, carefully review the Trailering section of the Owner's Manual. The trailering capacity of your specific vehicle may vary. The weight of passengers, cargo and options or accessories may reduce the amount you can trailer. <sup>3</sup> Cargo and load capacity limited by weight and distribution. <sup>4</sup> Vehicle user interface is a product of Apple and its terms and privacy statements apply. Requires compatible iPhone and data plan rates apply. <sup>5</sup> Vehicle user interface is a product of Google and its terms and privacy statements apply. To use Android Auto on your car display, you'll need an Android phone running Android 6 or higher, an active data plan, and the Android Auto app.

Apple CarPlay, iPhone, Siri and Apple Music are trademarks of Apple Inc., registered in the U.S. and other countries. Google, Android and Android Auto are trademarks of Google LLC.

## Four models to choose from.



### 2LT

Blazer 2LT is a perfect combination of style and capability.

- 2.0L Turbo engine
- 9-speed automatic transmission
- Signature Black grille with bright chrome header bar
- Circular dual-outlet exhaust
- 18-inch Bright Silver-painted aluminum wheels
- Remote vehicle starter system
- 8-way power driver seat
- Dual-zone automatic climate controls
- Keyless Open and Start
- Chevy Safety Assist<sup>1</sup>
- Chevrolet Infotainment 3 Plus system<sup>2</sup> with 10.2-inch diagonal color touch-screen
- Lockable electronic glove box

Midnight/Sport Edition available  
Redline Edition available



### 3LT

Interior upgrades and additional driver assistance features are key for 3LT.

- Programmable power liftgate
- Black roof rails
- Perforated leather-appointed seating surfaces
- 6-way power front passenger seat
- Lane Change Alert with Side Blind Zone Alert<sup>3</sup>
- Auto-dimming interior rearview mirror
- Universal Home Remote

Midnight/Sport Edition available  
Redline Edition available



### RS

Street-inspired looks and spirited performance are RS calling cards.

- 3.6L V6 engine, RS-specific steering ratio and tuned dampers
- Available two-tone roof
- Custom Black mesh grille with hexagonal design, Black Ice chrome header bar, Black bowtie emblem and RS badging
- Rectangular dual-outlet exhaust
- RS-specific 20-inch Technical Gray-painted aluminum wheels
- Hands-free power liftgate with Chevrolet emblem projection
- RS-exclusive Red-accented or Nightshift Blue-accented interior available
- Chevrolet Infotainment 3 Premium system<sup>2</sup> with Navigation<sup>4</sup>



### Premier

A richly refined interior is only the beginning in Premier.

- Signature bright chrome-accented grille with chrome header bar
- Silver-painted roof rails
- Integrated rectangular dual-outlet exhaust
- Premier-specific 20-inch machined-face aluminum wheels
- Chrome-accented body-color door handles
- Bright front sill plates
- Jet Black or Jet Black/Maple Sugar interior
- Perforated leather-appointed seating surfaces with sueded microfiber accents

<sup>1</sup> Chevy Safety Assist includes Automatic Emergency Braking, Front Pedestrian Braking, Lane Keep Assist with Lane Departure Warning, Forward Collision Alert, IntelliBeam and Following Distance Indicator. Safety or driver assistance features are no substitute for the driver's responsibility to operate the vehicle in a safe manner. Read the vehicle Owner's Manual for important feature limitations and information. <sup>2</sup> Chevrolet Infotainment System functionality varies by model. Full functionality requires compatible Bluetooth and smartphone, and USB connectivity for some devices. <sup>3</sup> Safety or driver assistance features are no substitute for the driver's responsibility to operate the vehicle in a safe manner. Read the vehicle Owner's Manual for important feature limitations and information. <sup>4</sup> Map coverage available in the United States, Puerto Rico and Canada.

# 2LT



Summit White



Iridescent Pearl Tricoat<sup>1</sup>



Sterling Gray Metallic



Copper Bronze Metallic



Red Hot



Radiant Red Tintcoat<sup>1</sup>



Blue Glow Metallic



Black



Black/Iridescent Pearl Tricoat<sup>1,2</sup>



Black/Sterling Gray Metallic<sup>2</sup>



Black/Blue Glow Metallic<sup>2</sup>

<sup>1</sup> Extra-cost color. <sup>2</sup> Requires available Midnight/Sport Edition.



## 2LT



Select standard features:

### MECHANICAL

Engine – 2.0L turbocharged DOHC 4-cylinder with Variable Valve Timing (VVT), Direct Injection and Automatic Stop/Start

Exhaust – dual-outlet with circular bright tips

Transmission – 9-speed automatic, electronically controlled with overdrive and Driver Shift Control

### EXTERIOR

Glass – deep-tinted rear windows and liftgate

Grille – signature Black grille with bright chrome header bar

Mirrors – heated, power-adjustable, manual-folding with body-color caps

### INTERIOR

Air conditioning – automatic, dual-zone with individual climate settings for driver and front passenger

Cruise control – electronic with Set and Resume Speed

Driver Information Center – 4.2-inch diagonal multi-color display with digital compass

Entertainment – Chevrolet Infotainment 3 Plus system<sup>1</sup> with 10.2-inch diagonal HD color touch-screen

Keyless Open and Start – includes extended-range Remote Keyless Entry

Media – two USB ports<sup>2</sup>; one Type-A and one Type-C, on instrument panel; two charge-only USB ports<sup>2</sup>; one Type-A and one Type-C, on rear of center console

Remote vehicle starter system

Seat – driver 8-way power adjuster with power lumbar control

SiriusXM<sup>®3</sup> – 3-month trial subscription to SXM Platinum Plan

Steering column – manual tilt and telescopic

Steering wheel – with mounted audio, cruise and phone controls

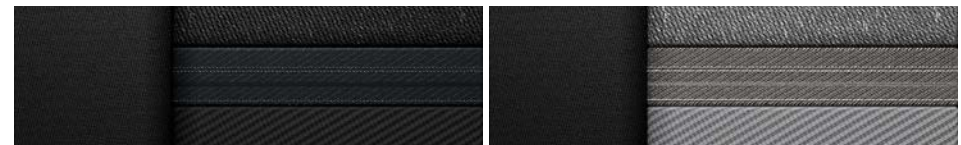

Jet Black Premium Cloth (shown)

Jet Black/Medium Ash Gray Premium Cloth



18" Grazen Metallic Aluminum Wheels  
Standard on 2LT



18" High-Gloss Black-Painted Aluminum Wheels  
Available on 2LT with Midnight/Sport Edition



20" Bright Silver-Painted Aluminum Wheels  
Available on 2LT



20" Gloss Black-Painted Aluminum Wheels  
Available on 2LT



20" Gloss Black-Painted Aluminum Wheels with Red Accents  
Available on 2LT with Redline Edition

<sup>1</sup> Chevrolet Infotainment System functionality varies by model. Full functionality requires compatible Bluetooth and smartphone, and USB connectivity for some devices. <sup>2</sup> Not compatible with all devices. <sup>3</sup> If you decide to continue service after your trial, your selected subscription plan will automatically renew thereafter. You will be charged at then-current rates. Fees and taxes apply. To cancel you must call SiriusXM at 1-866-635-2349. See SiriusXM Customer Agreement for complete terms at [siriusxm.com](http://siriusxm.com). All fees and programming subject to change.

# 3LT



Summit White



Iridescent Pearl Tricoat<sup>1</sup>



Sterling Gray Metallic



Copper Bronze Metallic



Red Hot



Radiant Red Tintcoat<sup>1</sup>



Blue Glow Metallic



Black



Black/Iridescent Pearl Tricoat<sup>1,2</sup>



Black/Sterling Gray Metallic<sup>2</sup>



Black/Blue Glow Metallic<sup>2</sup>

<sup>1</sup> Extra-cost color. <sup>2</sup> Requires available Midnight/Sport Edition.

## 3LT



Select standard features:

**MECHANICAL**

Engine – 2.0L turbocharged DOHC 4-cylinder with Variable Valve Timing (VVT), Direct Injection and Automatic Stop/Start

Exhaust – dual-outlet with circular bright tips

Transmission – 9-speed automatic, electronically controlled with overdrive and Driver Shift Control

**EXTERIOR**

Glass – deep-tinted rear windows and liftgate

Grille – signature Black grille with bright chrome header bar

Liftgate – power, programmable

Mirrors – heated, power-adjustable, manual-folding with body-color caps, integrated turn signal indicators and driver-side auto-dimming feature

Roof rails – Black

**INTERIOR**

Entertainment – Chevrolet Infotainment 3 Plus system<sup>1</sup> with 10.2-inch diagonal HD color touch-screen

Keyless Open and Start – includes extended-range Remote Keyless Entry

Lane Change Alert with Side Blind Zone Alert<sup>2</sup>

Mirror – rearview, auto-dimming

Rear Cross Traffic Alert<sup>2</sup>

Seat – driver 8-way power adjuster with power lumbar control  
– front passenger 6-way power adjuster

SiriusXM<sup>®3</sup> – 3-month trial subscription to SXM Platinum Plan

Steering column – manual tilt and telescopic

Steering wheel – wrapped, with mounted audio, cruise and phone controls

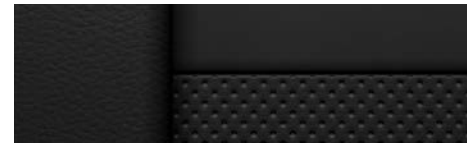

Jet Black Perforated Leather-Appointed Seating Surfaces



18" Grazen Metallic  
Aluminum Wheels  
Standard on 3LT



18" High-Gloss Black-Painted  
Aluminum Wheels  
Available on 3LT with  
Midnight/Sport Edition



20" Bright Silver-Painted  
Aluminum Wheels  
Available on 3LT



20" Gloss Black-Painted  
Aluminum Wheels  
Available on 3LT



20" Gloss Black-Painted Aluminum  
Wheels with Red Accents  
Available on 3LT with Redline Edition

<sup>1</sup> Chevrolet Infotainment System functionality varies by model. Full functionality requires compatible Bluetooth and smartphone, and USB connectivity for some devices. <sup>2</sup> Safety or driver assistance features are no substitute for the driver's responsibility to operate the vehicle in a safe manner. Read the vehicle Owner's Manual for important feature limitations and information. <sup>3</sup> If you decide to continue service after your trial, your selected subscription plan will automatically renew thereafter. You will be charged at then-current rates. Fees and taxes apply. To cancel you must call SiriusXM at 1-866-635-2349. See SiriusXM Customer Agreement for complete terms at [siriusxm.com](http://siriusxm.com). All fees and programming subject to change.



# RS



Black/Iridescent Pearl Tricoat<sup>1,2</sup>



Sterling Gray Metallic



Black/Sterling Gray Metallic<sup>2</sup>



Black/Nitro Yellow Metallic<sup>1,2</sup>



Red Hot



Black/Red Hot<sup>2</sup>



Radiant Red Tintcoat<sup>1</sup>



Black/Radiant Red Tintcoat<sup>1,2</sup>



Black

<sup>1</sup>Extra-cost color. <sup>2</sup>Requires available Black two-tone roof.

## RS



Select standard features:

**MECHANICAL**

Engine – 3.6L DOHC V6 with Variable Valve Timing (VVT), Direct Injection and Automatic Stop/Start

Exhaust – dual-outlet with rectangular bright tips

RS enhancements – specific steering ratio and tuned dampers

Transmission – 9-speed automatic, electronically controlled with overdrive and Driver Shift Control

**EXTERIOR**

Chevrolet bowtie emblems – Black

Grille – gloss Black hexagonal design with Black Ice chrome header bar and RS badging

Liftgate – power, programmable, hands-free with Chevrolet emblem projection

**INTERIOR**

Audio – Bose premium 8-speaker sound system with subwoofer

Driver Information Center – enhanced 8-inch diagonal reconfigurable multi-color display

Entertainment – Chevrolet Infotainment 3 Premium system<sup>1</sup> with Navigation<sup>2</sup> and 10.2-inch diagonal HD color touch-screen

Keyless Open and Start – includes extended-range Remote Keyless Entry

Lane Change Alert with Side Blind Zone Alert<sup>3</sup>

Lighting – ambient with pin spot lighting in the map pocket area, True White light pipes on the passenger side of the instrument panel and below the front door handles, and LED lighting between the center console cup holders

Power outlet – 120-volt, on rear of center console

Rear Cross Traffic Alert<sup>3</sup>

Remote vehicle starter system

Seat – driver 8-way power adjuster with power lumbar control  
– front passenger 6-way power adjuster

SiriusXM<sup>®</sup> with 360L<sup>4</sup> – 3-month trial subscription to SXM Platinum Plan

<sup>1</sup> Chevrolet Infotainment System functionality varies by model. Full functionality requires compatible Bluetooth and smartphone, and USB connectivity for some devices. <sup>2</sup> Map coverage available in the United States, Puerto Rico and Canada. <sup>3</sup> Safety or driver assistance features are no substitute for the driver's responsibility to operate the vehicle in a safe manner. Read the vehicle Owner's Manual for important feature limitations and information. <sup>4</sup> If you decide to continue service after your trial, your selected subscription plan will automatically renew thereafter. You will be charged at then-current rates. Fees and taxes apply. To cancel you must call SiriusXM at 1-866-635-2349. See SiriusXM Customer Agreement for complete terms at [siriusxm.com](http://siriusxm.com). All fees and programming subject to change. Certain features require a SiriusXM subscription and the Chevrolet Connected Access plan. See [siriusxm.com](http://siriusxm.com) and [onstar.com](http://onstar.com) for details and limitations.

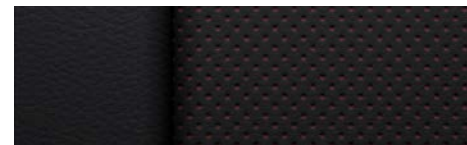
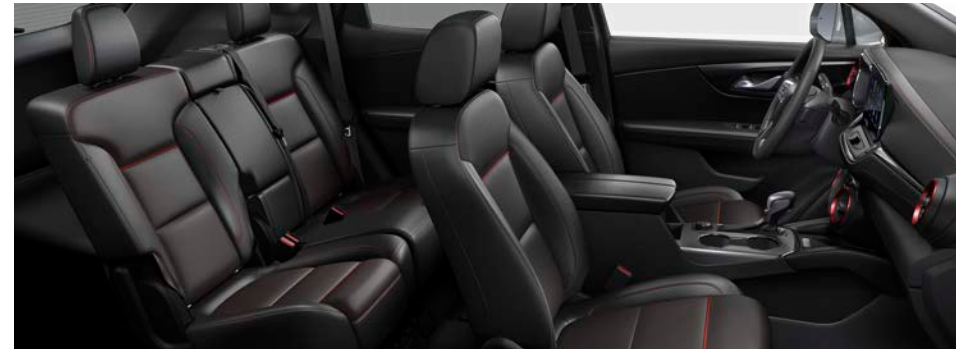

Jet Black Perforated Leather-Appointed Seating Surfaces with Red Accents (shown)

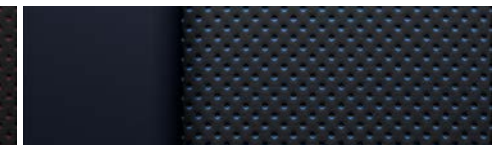

Jet Black/Nightshift Blue Perforated Leather-Appointed Seating Surfaces



20" Technical Gray-Painted Aluminum Wheels  
Standard on RS



21" High-Gloss Black-Painted  
Machined-Face Aluminum Wheels  
Available on RS

# Premier



Iridescent Pearl Tricoat<sup>1</sup>



Sterling Gray Metallic



Copper Bronze Metallic



Radiant Red Tintcoat<sup>1</sup>



Blue Glow Metallic



Black

<sup>1</sup>Extra-cost color.



# Premier



Select standard features:

## MECHANICAL

Engine – 2.0L turbocharged DOHC 4-cylinder with Variable Valve Timing (VVT), Direct Injection and Automatic Stop/Start

Exhaust – dual-outlet with rectangular bright tips integrated into fascia

Transmission – 9-speed automatic, electronically controlled with overdrive and Driver Shift Control

## EXTERIOR

Grille – signature Black grille with bright chrome accents and bright chrome header bar

Liftgate – power, programmable, hands-free with Chevrolet emblem projection

Roof rails – Silver-painted

## INTERIOR

Audio – Bose premium 8-speaker sound system with subwoofer

Driver Information Center – enhanced 8-inch diagonal reconfigurable multi-color display

Entertainment – Chevrolet Infotainment 3 Premium system<sup>1</sup> with Navigation<sup>2</sup> and 10.2-inch diagonal HD color touch-screen

Keyless Open and Start – includes extended-range Remote Keyless Entry

Lane Change Alert with Side Blind Zone Alert<sup>3</sup>

Lighting – ambient with pin spot lighting in the map pocket area, True White light pipes on the passenger side of the instrument panel and below the front door handles, and LED lighting between the center console cup holders

Power outlet – 120-volt, on rear of center console

Rear Cross Traffic Alert<sup>3</sup>

Remote vehicle starter system

Seat – driver 8-way power adjuster with power lumbar control  
– front passenger 6-way power adjuster

Sill plates – front, bright

SiriusXM<sup>®</sup> with 360L<sup>4</sup> – 3-month trial subscription to SXM Platinum Plan



Jet Black Perforated Leather-Appointed Seating Surfaces with Sueded Microfiber Accents



Jet Black/Maple Sugar Perforated Leather-Appointed Seating Surfaces with Sueded Microfiber Accents (shown)



20" Machined-Face Aluminum Wheels with Medium Android-Painted Pockets Standard on Premier



20" Gloss Black-Painted Aluminum Wheels Available on Premier



21" Triple Finish Aluminum Wheels Available on Premier

<sup>1</sup> Chevrolet Infotainment System functionality varies by model. Full functionality requires compatible Bluetooth and smartphone, and USB connectivity for some devices. <sup>2</sup> Map coverage available in the United States, Puerto Rico and Canada. <sup>3</sup> Safety or driver assistance features are no substitute for the driver's responsibility to operate the vehicle in a safe manner. Read the vehicle Owner's Manual for important feature limitations and information. <sup>4</sup> If you decide to continue service after your trial, your selected subscription plan will automatically renew thereafter. You will be charged at then-current rates. Fees and taxes apply. To cancel you must call SiriusXM at 1-866-635-2349. See SiriusXM Customer Agreement for complete terms at [siriusxm.com](http://siriusxm.com). All fees and programming subject to change. Certain features require a SiriusXM subscription and the Chevrolet Connected Access plan. See [siriusxm.com](http://siriusxm.com) and [onstar.com](http://onstar.com) for details and limitations.

● STANDARD ○ AVAILABLE – NOT AVAILABLE

	2LT	3LT	RS	PREMIER
<b>SAFETY AND DRIVER ASSISTANCE</b>				
Chevy Safety Assist <sup>1</sup>	●	●	●	●
Automatic Emergency Braking				
Front Pedestrian Braking				
Lane Keep Assist with Lane Departure Warning				
Forward Collision Alert				
IntelliBeam, auto high beams				
Following Distance Indicator				
Airbags <sup>2</sup> – frontal airbags for driver and front passenger; knee airbag for driver; seat-mounted side-impact airbags for driver and front passenger; head-curtain airbags for front and rear outboard seating positions; includes front Passenger Sensing System for passenger-side frontal airbag	●	●	●	●
Buckle to Drive	●	●	●	●
Enhanced Automatic Emergency Braking <sup>1</sup> (requires available Convenience Package on 2LT; requires available Sound & Technology Package on 3LT; requires available Driver Confidence II Package on RS and Premier)	○	○	○	○
Lane Change Alert with Side Blind Zone Alert <sup>1</sup> (requires available Driver Confidence Package on 2LT)	○	●	●	●
LATCH system (Lower Anchors and Tethers for CHildren) – for child restraint systems	●	●	●	●
Rear Cross Traffic Alert <sup>1</sup> (requires available Driver Confidence Package on 2LT)	○	●	●	●
Rear Park Assist <sup>1</sup> (requires available Driver Confidence Package on 2LT; feature will not function on certain models; see dealer for details or the window label for features on a specific vehicle)	○	○	○	○
HD Rear Vision Camera <sup>1</sup>	●	●	●	●
HD Surround Vision <sup>1</sup> – includes HD Rear Vision Camera <sup>1</sup> (requires available Sound & Technology Package on 3LT; requires available Driver Confidence II Package on RS and Premier)	–	○	○	○
Safety Alert Seat <sup>1</sup> (requires available Driver Confidence II Package)	–	–	○	○
Teen Driver technology <sup>1</sup>	●	●	●	●
Theft-deterrent system – unauthorized entry	●	●	●	●
Tire Pressure Monitoring System – with Tire Fill Alert (does not monitor spare tire)	●	●	●	●
Up to 3 months of OnStar <sup>®</sup> Safety & Security coverage <sup>3</sup>	●	●	●	●

	2LT	3LT	RS	PREMIER
<b>MECHANICAL</b>				
Air filter – engine air filtration monitor	●	●	●	●
All-wheel drive (AWD) – includes trailering equipment	○	○	–	○
– Advanced Twin-Clutch AWD; includes trailering equipment	–	–	○	–
Brakes – 4-wheel antilock, 4-wheel disc with Duralife <sup>®</sup> rotors; electronic parking brake	●	●	●	●
Cooling system – heavy-duty (included on AWD models; requires available 3.6L V6 engine and trailering equipment on 3LT and Premier; requires available trailering equipment on RS)	–	○	○	○
Driver Mode Selector – Tour (FWD), Sport, All-Wheel Drive (AWD), Snow/Ice, Tow/Haul and Off-Road	●	●	●	●
Engine – 2.0L turbocharged DOHC 4-cylinder with Variable Valve Timing (VVT), Direct Injection and Automatic Stop/Start with override; 228 hp @ 5500 rpm, 258 lb.-ft. of torque @ 1500–4000 rpm	●	●	–	●
– 3.6L DOHC V6 with Variable Valve Timing (VVT), Direct Injection and Automatic Stop/Start with override; 308 hp @ 6700 rpm, 270 lb.-ft. of torque @ 5000 rpm	–	○	●	○
Exhaust – dual-outlet with circular bright tips	●	●	–	–
– dual-outlet with rectangular bright tips	–	–	●	–
– dual-outlet with rectangular bright tips integrated into fascia	–	–	–	●
Hitch Guidance <sup>1</sup> – included on AWD models (requires available trailering equipment on FWD models)	○	○	○	○
Hitch View <sup>1</sup> – included on RS and Premier AWD (requires available Sound & Technology Package on 3LT AWD; requires available Sound & Technology Package and trailering equipment on 3LT FWD; requires available trailering equipment on RS and Premier FWD)	–	○	○	○
StabiliTrak <sup>®</sup> – Electronic Stability Control System with Traction Control; includes Hill Start Assist	●	●	●	●
Steering – power, electric	●	●	●	●
Suspension – front MacPherson strut	●	●	●	●
– rear 5-link, independent	●	●	●	●
Trailering equipment – includes Hitch Guidance <sup>1</sup> (included on AWD models; includes Hitch View <sup>1</sup> on 3LT with available Sound & Technology Package; includes heavy-duty cooling system on 3LT with available 3.6L V6 engine; includes Hitch View <sup>1</sup> and heavy-duty cooling system on RS; includes Hitch View <sup>1</sup> on Premier; includes heavy-duty cooling system on Premier with available 3.6L V6 engine)	○	○	○	○
Transmission – 9-speed automatic, electronically controlled with overdrive and Driver Shift Control	●	●	●	●

<sup>1</sup> Safety or driver assistance features are no substitute for the driver's responsibility to operate the vehicle in a safe manner. Read the vehicle Owner's Manual for important feature limitations and information. <sup>2</sup> A NOTE ON CHILD SAFETY: Always use seat belts and the correct child restraint for your child's age and size, even with airbags. Even in vehicles equipped with the Passenger Sensing System, children are safer when properly secured in a rear seat in the appropriate infant, child or booster seat. Never place a rear-facing infant restraint in the front seat of any vehicle equipped with an active frontal airbag. See your vehicle Owner's Manual and the child safety seat instructions for more safety information. <sup>3</sup> When you select a monthly plan within 15 days of activating your 1-month trial, you'll receive the next 2 months of the plan you select at no additional charge when you associate an approved payment method on file to your account and authorize recurring payments for your service plan. The amount and frequency of each recurring payment is based upon the service(s) and payment interval(s) you select from the options provided. After the trial expires, OnStar will automatically bill your payment method monthly at then-current standard monthly rates. Plans containing 4G LTE data will be billed every 30 days by AT&T. You may cancel at any time by pushing your blue OnStar button or calling 1-888-466-7827. May not be combined with other offers or retroactively applied. Offer subject to change.

● STANDARD ○ AVAILABLE – NOT AVAILABLE

	2LT	3LT	RS	PREMIER
<b>EXTERIOR</b>				
Active aero grille shutters	●	●	●	●
Antenna – roof-color	●	●	●	●
Chevrolet bowtie emblems – Black	○	○	●	○
Daytime running lamps – LED	●	●	●	●
Door handles – body-color	●	●	●	–
– body-color with chrome accent	–	–	–	●
Fuel filler – capless fueling	●	●	●	●
Glass – deep-tinted rear windows and liftgate	●	●	●	●
Grille – signature Black grille with bright chrome header bar	●	●	–	–
– gloss Black hexagonal design with Black Ice chrome header bar and RS badging	–	–	●	–
– signature Black grille with bright chrome accents and bright chrome header bar	–	–	–	●
Headlamps – LED	●	●	●	●
– automatic on/off with automatic delay	●	●	●	●
Liftgate – manual	●	–	–	–
– power, programmable (requires available Convenience Package on 2LT)	○	●	–	–
– power, programmable, hands-free with Chevrolet emblem projection	–	–	●	●
Mirrors – heated, power-adjustable, manual-folding	●	–	–	–
– heated, power-adjustable, manual-folding with integrated turn signal indicators and driver-side auto-dimming feature	–	●	●	●
– body-color caps	●	●	●	●
– Black caps (requires available Midnight/Sport Edition or Redline Edition)	○	○	–	–
Moldings – Black lower bodyside	●	●	–	–
– high-gloss Black-painted lower bodyside with Black Ice chrome inserts	–	–	●	–
– Iron Gray Metallic lower bodyside with chrome inserts	–	–	–	●

	2LT	3LT	RS	PREMIER
<b>EXTERIOR (CONTINUED)</b>				
Roof rails – Black (requires available Convenience Package or Midnight/Sport Edition on 2LT)	○	●	●	–
– Silver-painted	–	–	–	●
Roof, two-tone – Black (requires available Midnight/Sport Edition and Iridescent Pearl Tricoat; Sterling Gray Metallic or Blue Glow Metallic exterior color on 2LT and 3LT; requires Iridescent Pearl Tricoat; <sup>1</sup> Sterling Gray Metallic, Nitro Yellow Metallic; Red Hot or Radiant Red Tintcoat <sup>1</sup> exterior color on RS)	○	○	○	–
Taillamps – LED	●	●	●	●
Tires – P235/65R18 all-season	●	●	–	–
– P235/55R20 all-season (requires available Redline Edition, 20" gloss Black-painted aluminum wheels or 20" Bright Silver-painted aluminum wheels on 2LT and 3LT)	○	○	●	●
– P265/45R21 all-season (requires available 21" aluminum wheels)	–	–	○	○
– compact spare	●	●	●	●
Wheels – 18" Grazen Metallic aluminum	●	●	–	–
– 18" high-gloss Black-painted aluminum (requires available Midnight/Sport Edition)	○	○	–	–
– 20" Technical Gray-painted aluminum	–	–	●	–
– 20" machined-face aluminum with Medium Android-painted pockets	–	–	–	●
– 20" gloss Black-painted aluminum with Red accents (requires available Redline Edition)	○	○	–	–
– 20" gloss Black-painted aluminum	○	○	–	○
– 20" Bright Silver-painted aluminum	○	○	–	–
– 21" high-gloss Black-painted machined-face aluminum	–	–	○	–
– 21" Triple Finish aluminum	–	–	–	○
Wipers – front variable-speed, intermittent with washer; rear intermittent with washer	●	●	●	●

<sup>1</sup>Extra-cost color.



● STANDARD ○ AVAILABLE – NOT AVAILABLE

	2LT	3LT	RS	PREMIER
<b>INTERIOR</b>				
Active Noise Cancellation	●	●	●	●
Air conditioning – automatic, dual-zone with individual climate settings for driver and front passenger, and cabin humidity sensor	●	●	●	●
– air filtration system	●	●	●	●
– rear console air vents	●	●	●	●
Armrest – rear-seat center	●	●	●	●
Assist handles – overhead, front passenger and rear outboard	●	●	●	●
Cruise control – electronic with Set and Resume Speed	●	●	●	●
– Adaptive Cruise Control <sup>1</sup> (requires available Convenience Package on 2LT; requires available Sound & Technology Package on 3LT; requires available Driver Confidence II Package on RS and Premier)	○	○	○	○
Cup holders – two in front center console, two in rear center armrest and a bottle holder in each door	●	●	●	●
Door locks – power programmable with lockout protection and manual rear door child security	●	●	●	●
Driver Information Center – 4.2-inch diagonal multi-color display	●	●	–	–
– enhanced 8-inch diagonal reconfigurable multi-color display	–	–	●	●
– digital compass	●	●	●	●
Floor mats – front and rear, carpeted	●	●	●	●
Glove box – lockable electronic	●	●	●	●
Keyless Open and Start – includes extended-range Remote Keyless Entry	●	●	●	●
Lighting – front reading lamps, overhead courtesy lamp, dual rear quarter panel area dome lamps, True White backlit switches, True White pin spot lighting in the bin forward of the shifter and front footwells and backlit USB ports <sup>2</sup>	●	●	●	●
– ambient with pin spot lighting in the map pocket area, True White light pipes on the passenger side of the instrument panel and below the front door handles, and LED lighting between the center console cup holders	–	–	●	●
Memory settings – recalls two presets for power driver seat, exterior mirrors, and power tilt and telescopic steering column (requires available Enhanced Convenience Package)	–	–	○	○
Mirror – rearview, manual day/night	●	–	–	–
– rearview, auto-dimming (requires available Convenience Package on 2LT)	○	●	●	●
– Rear Camera Mirror <sup>1</sup> with washer, full camera display (requires available Sound & Technology Package on 3LT; requires available Driver Confidence II Package on RS and Premier)	–	○	○	○
Power outlet – 12-volt auxiliary	●	●	●	●
– 120-volt, on rear of center console (requires available Sound & Technology Package on 3LT)	–	○	●	●

	2LT	3LT	RS	PREMIER
<b>INTERIOR (CONTINUED)</b>				
Rear Seat Reminder <sup>3</sup> notification	●	●	●	●
Remote vehicle starter system	●	●	●	●
Shift knob – wrapped	–	●	●	●
Sill plates – front, bright	–	–	–	●
Steering column – manual tilt and telescopic	●	●	●	●
– power tilt and telescopic (requires available Enhanced Convenience Package)	–	–	○	○
Steering wheel – with mounted audio, cruise and phone controls	●	–	–	–
– wrapped, with mounted audio, cruise and phone controls	–	–	●	●
– heated with selectable automatic activation	–	–	●	●
Sunroof – panoramic power with power sunshade	–	○	○	○
Temperature display – outside	●	●	●	●
Trunk – cargo anchors	●	●	●	●
Umbrella holders – driver and front passenger doors	●	●	●	●
Universal Home Remote – programmable, includes garage door opener (requires available Convenience Package on 2LT)	○	●	●	●
Visors – driver and front passenger illuminated vanity mirrors, covered	●	●	●	●
Windows – power with driver express-up/-down, all others express-down	●	●	●	●
<b>SEATING</b>				
Seats – front bucket	●	●	●	●
– rear adjustable sliding, manual-folding 60/40 split-bench with center armrest and recline	●	●	●	●
Seat – driver 8-way power adjuster with power lumbar control	●	●	●	●
– front passenger 4-way manual adjuster	●	–	–	–
– front passenger 6-way power adjuster	–	●	●	●
Heated front seats (requires available Convenience Package on 2LT)	○	●	●	●
Heated rear outboard seating positions (requires available Enhanced Convenience Package)	–	–	○	○
Ventilated front seats (requires available Enhanced Convenience Package)	–	–	○	○
Seat release – second-row mechanical levers in cargo area	●	●	●	●

<sup>1</sup> Safety or driver assistance features are no substitute for the driver's responsibility to operate the vehicle in a safe manner. Read the vehicle Owner's Manual for important feature limitations and information. <sup>2</sup> Not compatible with all devices. <sup>3</sup> Does not detect people or items. Always check rear seat before exiting.

● STANDARD ○ AVAILABLE – NOT AVAILABLE

	2LT	3LT	RS	PREMIER
<b>ENTERTAINMENT</b>				
Chevrolet Infotainment 3 Plus system <sup>1</sup> with 10.2-inch diagonal HD color touch-screen, AM/FM stereo, Bluetooth <sup>®</sup> audio streaming <sup>2</sup> for two active devices, voice command pass-through to compatible phone, wireless Apple CarPlay <sup>®3</sup> and wireless Android Auto <sup>™4</sup> compatibility, available Alexa Built-in <sup>5</sup> ; enhanced voice recognition, available In-Vehicle Apps <sup>6</sup> and Chevrolet Maps <sup>+7</sup>	●	●	–	–
Chevrolet Infotainment 3 Premium system <sup>1</sup> with Navigation <sup>8</sup> and 10.2-inch diagonal HD color touch-screen, AM/FM stereo, Bluetooth audio streaming <sup>2</sup> for two active devices, voice command pass-through to compatible phone, wireless Apple CarPlay <sup>3</sup> and wireless Android Auto <sup>4</sup> compatibility, available Alexa Built-in <sup>5</sup> ; enhanced voice recognition, additional memory for available In-Vehicle Apps <sup>6</sup> and Connected Navigation <sup>9</sup> (requires available Sound & Technology Package on 3LT)	–	○	●	●
Audio – 6-speaker system	●	●	–	–
– 8-speaker Bose premium audio system, includes center instrument panel speaker and subwoofer (requires available Sound & Technology Package on 3LT)	–	○	●	●
Media – two USB ports, <sup>10</sup> one Type-A and one Type-C, on instrument panel; two charge-only USB ports, <sup>10</sup> one Type-A and one Type-C, on rear of center console	●	●	●	●
– two USB ports, <sup>10</sup> one Type-A and one Type-C, SD card reader and auxiliary input jack in front center storage bin (requires available Sound & Technology Package on 3LT)	–	○	●	●
SiriusXM <sup>®</sup> with 360L <sup>11</sup> – 3-month trial subscription to SXM Platinum Plan (requires available Sound & Technology Package on 3LT)	–	○	●	●
Available Wi-Fi <sup>®</sup> Hotspot <sup>12</sup> for up to seven devices, includes 1-month Unlimited Data Plan	○	○	○	○
Chevrolet Connected Access <sup>13</sup> with up to 10 years of standard connectivity, which currently enables features such as Vehicle Diagnostics and Dealer Maintenance Notification	●	●	●	●
Wireless charging <sup>14</sup> (requires available Convenience Package on 2LT; requires available Sound & Technology Package on 3LT) (feature will not function on certain models; see dealer for details or the window label for features on a specific vehicle)	○	○	○	○

<sup>1</sup> Chevrolet Infotainment System functionality varies by model. Full functionality requires compatible Bluetooth and smartphone, and USB connectivity for some devices. <sup>2</sup> Go to [my.chevrolet.com/learnAbout/bluetooth](http://my.chevrolet.com/learnAbout/bluetooth) to find out which phones are compatible with the vehicle. Full Bluetooth feature functionality varies by device, model and software version. <sup>3</sup> Vehicle user interface is a product of Apple and its terms and privacy statements apply. Requires compatible iPhone and data plan rates apply. <sup>4</sup> Vehicle user interface is a product of Google and its terms and privacy statements apply. To use Android Auto on your car display, you'll need an Android phone running Android 6 or higher, an active data plan, and the Android Auto app. <sup>5</sup> Functionality is subject to limitations and varies by vehicle, infotainment system and location. Select service plan required. Certain Alexa Skills require account linking to use. Visit [onstar.com](http://onstar.com) for additional details. <sup>6</sup> Third-party trademarks are the property of their respective third-party owners and used under agreement. Requires active service plan and paid AT&T vehicle data plan. Visit [onstar.com](http://onstar.com) for details and limitations. <sup>7</sup> U.S. only. Requires select service plan. Functionality is subject to user terms and limitations and varies by vehicle model. Visit [onstar.com](http://onstar.com) for details and limitations. <sup>8</sup> Map coverage available in the United States, Puerto Rico and Canada. <sup>9</sup> Connected Navigation and Real-time Points of Interest (POI) only available on properly equipped vehicles. Requires paid plan or trial. Map coverage available in the United States, Puerto Rico and Canada. Visit [onstar.com](http://onstar.com) for details and limitations. <sup>10</sup> Not compatible with all devices. <sup>11</sup> If you decide to continue service after your trial, your selected subscription plan will automatically renew thereafter. You will be charged at then-current rates. Fees and taxes apply. To cancel you must call SiriusXM at 1-866-635-2349. See SiriusXM Customer Agreement for complete terms at [siriusxm.com](http://siriusxm.com). All fees and programming subject to change. Certain features require a SiriusXM subscription and the Chevrolet Connected Access plan. See [siriusxm.com](http://siriusxm.com) and [onstar.com](http://onstar.com) for details and limitations. <sup>12</sup> Service varies with conditions and location. Requires active service and paid AT&T data plan. Visit [onstar.com](http://onstar.com) for details and limitations. Availability subject to change. <sup>13</sup> Standard connectivity available only to original purchaser for up to 10 years. Connected Access services are subject to change. Does not include emergency or security services. Diagnostic capabilities vary by model and service plan. Message and data rates may apply. Requires contact method on file and enrollment to receive alerts. Not all issues will deliver alerts. Visit [onstar.com](http://onstar.com) for details and limitations. <sup>14</sup> The system wirelessly charges one compatible mobile device. Some phones have built-in wireless charging technology and others require a special adaptor/back cover. To check for phone or other device compatibility, see [my.chevrolet.com/learn](http://my.chevrolet.com/learn) or consult your carrier.

● STANDARD ○ AVAILABLE – NOT AVAILABLE



Midnight/Sport Edition.



Redline Edition.

2LT  
3LT  
RS  
PREMIER

#### PACKAGES AND SPECIAL EDITIONS

##### Convenience Package

Enhanced Automatic Emergency Braking<sup>1</sup>; Adaptive Cruise Control<sup>1</sup>; Universal Home Remote, programmable power liftgate, Black roof rails, inside rearview auto-dimming mirror, heated front seats and wireless charging<sup>2</sup> (wireless charging feature will not function on certain models; see dealer for details or the window label for features on a specific vehicle)

○ - - -

##### Driver Confidence Package

Lane Change Alert with Side Blind Zone Alert<sup>1</sup>; Rear Cross Traffic Alert<sup>1</sup> and Rear Park Assist<sup>1</sup> (Rear Park Assist feature will not function on certain models; see dealer for details or the window label for features on a specific vehicle)

○ - - -

##### Midnight/Sport Edition

18" high-gloss Black-painted aluminum wheels, gloss Black Blazer badges and grille bar, and Black Chevrolet bowtie emblems and mirror caps; includes Black roof rails on 2LT

○ ○ - -

##### Redline Edition

20" gloss Black-painted aluminum wheels with Red accents, Black Blazer badges with Red outline, Black Chevrolet bowtie emblems, Redline decals, and Black grille, header bar, window surround, mirror caps and door handles (requires available Jet Black interior and Convenience Package on 2LT) (available with Summit White or Black exterior colors)

○ ○ - -

##### Sound & Technology Package

Chevrolet Infotainment 3 Premium system<sup>3</sup> with Navigation<sup>4</sup> and 10.2-inch diagonal HD color touch-screen, 8-speaker Bose premium audio system, two USB ports<sup>5</sup> and SD card reader in front center storage bin, Enhanced Automatic Emergency Braking<sup>1</sup>; Adaptive Cruise Control<sup>1</sup>; HD Surround Vision<sup>1</sup>; Rear Camera Mirror<sup>1</sup>; 120-volt power outlet on rear of center console and wireless charging<sup>2</sup> (wireless charging feature will not function on certain models; see dealer for details or the window label for features on a specific vehicle)

- ○ - -

##### Driver Confidence II Package

Enhanced Automatic Emergency Braking<sup>1</sup>; Adaptive Cruise Control<sup>1</sup>; HD Surround Vision<sup>1</sup>; Rear Camera Mirror<sup>1</sup> and Safety Alert Seat<sup>1</sup>

- - ○ ○

##### Enhanced Convenience Package

Memory settings, power tilt and telescopic steering column, ventilated front seats and heated rear outboard seating positions

- - ○ ○

<sup>1</sup> Safety or driver assistance features are no substitute for the driver's responsibility to operate the vehicle in a safe manner. Read the vehicle Owner's Manual for important feature limitations and information. <sup>2</sup> The system wirelessly charges one compatible mobile device. Some phones have built-in wireless charging technology and others require a special adaptor/back cover. To check for phone or other device compatibility, see [my.chevrolet.com/learn](http://my.chevrolet.com/learn) or consult your carrier. <sup>3</sup> Chevrolet Infotainment System functionality varies by model. Full functionality requires compatible Bluetooth and smartphone, and USB connectivity for some devices. <sup>4</sup> Map coverage available in the United States, Puerto Rico and Canada. <sup>5</sup> Not compatible with all devices.



## MAXIMUM CAPACITIES

Fuel tank (approximate)	19.4 gallons - FWD 21.7 gallons - AWD
Passenger volume	107.8 cubic feet
Seating (front/rear)	Seats 2/3
Cargo volume <sup>1</sup>	Behind rear seat: 30.5 cubic feet Behind front seats: 64.2 cubic feet

## DIMENSIONS

A - Wheelbase	112.7"
B - Length	191.9"
C - Height	67.0"

## EPA-ESTIMATED FUEL ECONOMY

2.0L Turbo FWD	22 MPG city/29 highway/25 combined
2.0L Turbo AWD	22 MPG city/27 highway/24 combined
3.6L FWD	19 MPG city/27 highway/22 combined
3.6L AWD	19 MPG city/26 highway/21 combined

D - Front track	66.4"
Rear track	66.2"
E - Width	76.7"

Head room (front/rear)	39.8"/38.6"
Head room with sunroof (front/rear)	38.0"/36.8"
Leg room (front/rear)	41.0"/39.6"
Shoulder room (front/rear)	59.1"/58.6"
Hip room (front/rear)	55.6"/54.2"

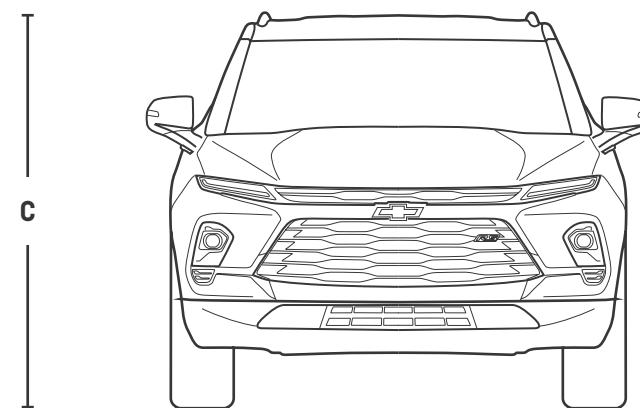
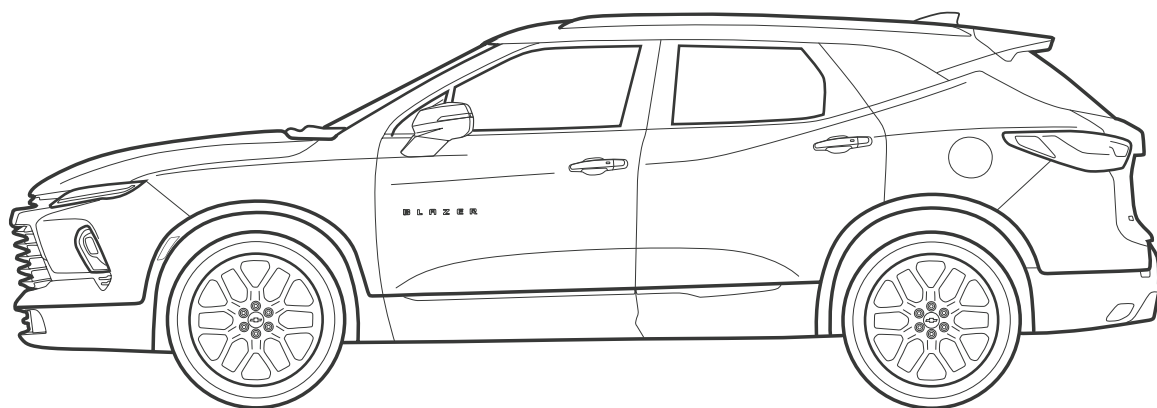

<sup>1</sup> Cargo and load capacity limited by weight and distribution.



Floor Liners available from Chevrolet Accessories.



Molded Assist Steps available from Chevrolet Accessories.



Cargo Liner available from Chevrolet Accessories.



Grille Bar Insert in Black available from Chevrolet Accessories.



## Important information.

You may be discovering Chevrolet through a personalized online shopping experience or enjoying every year of vehicle ownership. Either way, we're committed to providing the tools and programs you need to help you get the most out of your journey.

### Build & Price >

Create your perfect Chevrolet from start to finish.

### Chevy MyWay<sup>1</sup> >

Engage in a real-time virtual video experience with a Chevy product specialist.

### Chevrolet Complete Care >

Enjoy an owner benefit program that provides excellent service and support from day one.

### My Chevrolet Rewards<sup>2</sup> >

Unlock a world of appreciation that's all about you and your Chevrolet. Start earning and redeeming today.

### Limited Warranty Coverage >

Discover all the ways Chevrolet is committed to providing an excellent ownership experience.



GM, the GM logo, Chevrolet, the Chevrolet logo, and the slogans, emblems, vehicle model names, vehicle body designs and other marks appearing in this brochure are the trademarks and/or service marks of General Motors, its subsidiaries, affiliates or licensors. ©2022 OnStar LLC. All rights reserved. Sirius, XM, SiriusXM and all related marks and logos are trademarks of Sirius XM Radio Inc. Amazon, Alexa and all related marks are trademarks of Amazon.com, Inc. or its affiliates. The Bluetooth word mark is a registered trademark owned by Bluetooth SIG, Inc., and any use of such mark by Chevrolet is under license. Bose is a registered trademark of the Bose Corp.

©2022 General Motors. All rights reserved. October 2022

**FIND NEW ROADS™**

**CHEVROLET.COM**

<sup>1</sup> Chevy MyWay is available to anyone over 18 in the United States to access and experience via [chevrolet.com/myway](https://chevrolet.com/myway). <sup>2</sup> Must be 18 years or older. Points may be earned and redeemed only at GM entities, My Chevrolet Rewards participating dealers or third party retailers in the United States (excluding Puerto Rico, the U.S. Virgin Islands or Guam). Points are not earned on taxes, fees or body shop repair orders and expire without further notice upon Member Account deactivation. Visit [myChevroletrewards.com](https://myChevroletrewards.com) to view My GM Rewards Terms & Conditions.