

09CHESUVCAT01

09

 CHEVY TAHOE | SUBURBAN | AVALANCHE



AN AMERICAN REVOLUTION 

For more information, go to [chevy.com](http://chevy.com) 



## ONE FAMILY. ONE GOAL.

The vehicles you see here have a singular purpose — to fulfill the needs of the people who drive them. | Fuel efficiency, capability and legendary Chevy dependability are characteristics they all share. You might call them family traits. | When equipped with the Vortec 5.3L V8 engine, Tahoe and Suburban 2WD offer an EPA estimated MPG 20 highway — that's better than any competitor<sup>1</sup>. Avalanche 2WD offers that same highway mileage. Then there are Tahoe Hybrid<sup>2</sup> (at participating dealers only) and Tahoe XFE<sup>3</sup> taking efficiency one step further. | Of course, Chevy DNA means their capability is unquestioned. | And they're backed by the best coverage in America: the Chevy 100,000 mile/5-year<sup>4</sup> Transferable Powertrain Limited Warranty plus Roadside Assistance and Courtesy Transportation. | So choose your truck and count on one thing: This family will never let you down.

<sup>1</sup> Based on 2008 GM Large Utility segment and latest available competitive information. Excludes other GM vehicles. <sup>2</sup> EPA est. MPG 21 city, 22 highway (2WD). <sup>3</sup> Available October 2008. Est. MPG 15 city, 21 highway (2WD). Based on GM testing. <sup>4</sup> Whichever comes first. See dealer for details.

2 From left to right: Suburban half-ton LTZ 4x4 in Dark Blue Metallic with available Chevy Accessories; Avalanche LTZ 4x4 in Graystone Metallic with available Chevy Accessories; Tahoe Hybrid in Summit White.

For more information, go to [chevy.com](http://chevy.com)

## THE OVERACHIEVER.



FUEL EFFICIENCY

Every year, we strive to produce **THE BEST TAHOE EVER**. Because for people who need **OUTSTANDING EFFICIENCY AND FULL-SIZE SUV CAPABILITY**, only Tahoe will do.

| New for 2009, Tahoe XFE<sup>1</sup> offers an estimated MPG 15 city, 21 highway. That's **BETTER FUEL ECONOMY THAN ANY COMPETITOR<sup>2</sup>** – including Toyota Sequoia and Ford Expedition. We're further sharpening our focus on environmental responsibility with Tahoe Hybrid (at participating dealers only). | **POWERFUL VORTEC ENGINES** and the available Z71 Off-Road Package on 2LT models give you the ability to handle daily challenges or leave paved roads behind. | **FIVE-STAR FRONTAL AND SIDE-IMPACT CRASH TEST RATINGS<sup>3</sup>** and standard head-curtain side-impact air bags<sup>4</sup> for all rows help keep you safe on the road.

1 Available October 2008. 2 Based on 2008 GM Large Utility segment and latest available competitive information. Tahoe XFE estimated MPG 15 city, 21 highway (based on GM testing). EPA est. MPG (city/highway): Sequoia 14/19; Expedition 12/18. Excludes other GM vehicles. 3 Side-impact crash test rating is for a model tested with standard head-curtain side-impact air bags (SABs). Government star ratings are part of the National Highway Traffic Safety Administration's (NHTSA's) New Car Assessment Program ([www.safercar.gov](http://www.safercar.gov)). 4 Always use safety belts and the correct child restraint for your child's age and size. Even in vehicles equipped with the Passenger Sensing System, children are safer when properly secured in a rear seat in the appropriate infant, child or booster seat. Never place a rear-facing infant restraint in the front seat of any vehicle equipped with an active air bag. See the Owner's Manual and child safety seat instructions for more safety information. 5 Based on 2008 GM Large Utility segment and latest available competitive information. Excludes other GM vehicles.



New for 2009 and available on LS, 1LT and 2LT 2WD models, Tahoe XFE<sup>1</sup> offers an estimated MPG 21 highway (based on GM testing) – that's better than its competitors<sup>5</sup>. XFE also features an aluminum block Vortec 5.3L V8 engine and a 3.08 rear axle ratio.

GROWTH IN NATURE OCCURS ORGANICALLY – FLOWING FROM THE ROOTS TO THE TRUNK AND FROM THE BRANCHES TO THE LEAVES. SUCH WAS THE THOUGHT IN BRINGING TAHOE HYBRID TO LIFE, WHERE ONE IDEA GREW INTO THE NEXT, CREATING THE MOST FUEL-EFFICIENT FULL-SIZE SUV.<sup>6</sup>



## TAHOE HYBRID. THE NATURAL BORN LEADER.



HYBRID

The *Green Car Journal's* 2008 GREEN CAR OF THE YEAR<sup>1</sup> isn't a car at all. Meet the two-mode Tahoe Hybrid (at participating dealers only), the FIRST FULL-SIZE HYBRID SUV IN AMERICA<sup>2</sup> and it offers an EPA estimated MPG 21 city, 22 highway for 2WD models.<sup>2</sup> | Tahoe Hybrid delivers the power and capability you expect from a Chevy SUV while doing its part to help reduce our dependence on gasoline. In fact, 2WD models offer the SAME CITY FUEL EFFICIENCY AS A STANDARD FOUR-CYLINDER TOYOTA CAMRY.<sup>3</sup> | In Mode 1, at low speeds and with light loads, the vehicle can operate three ways – electric power, engine power or a combination of the two. When the vehicle operates on electric power, you receive all the benefits of a full hybrid system. | In Mode 2, used primarily at highway speeds, electric assist is provided in addition to the four-cylinder or full eight-cylinder engine power you get with Active Fuel Management

technology. | You'll also find aerodynamic improvements and weight savings throughout. | Comes standard with three years of XM NAVTRAFFIC<sup>4</sup> service, which displays real-time traffic information on your navigation system. | Go to [chevy.com/hybrid](http://chevy.com/hybrid) to learn more about Tahoe Hybrid.

1 Go to [GreenCar.com](http://GreenCar.com) for more information. 2 Excludes other GM vehicles. 3 EPA est. MPG 21 city. 4 Required XM Radio and XM NavTraffic monthly subscriptions sold separately after trial period. XM NavTraffic only available in select markets. All fees and programming subject to change. Subscriptions subject to customer agreement available at [gm.xmradio.com](http://gm.xmradio.com). XM service only available in the 48 contiguous United States. 5 Map coverage not available in Puerto Rico, the Virgin Islands and portions of Canada. 6 Based on 2008 GM Large Utility segment and latest available competitive information. Excludes other GM vehicles.



INSIDE TAHOE HYBRID, a power flow diagram on the navigation radio<sup>5</sup> screen informs the driver of how the hybrid system is currently functioning.



Tahoe Hybrid in Summit White.

For more information, go to [chevy.com](http://chevy.com)

## THE PATRIARCH.

The history of the full-size utility vehicle began 73 years ago with Chevy Suburban. | We take that responsibility seriously, which is why **SUBURBAN CONTINUES TO FILL YOUR BIG NEEDS** with powerful Vortec engines. This includes the standard 5.3L V8 engine in half-ton models that incorporates Active



FUEL EFFICIENCY

Fuel Management technology and helps **SUBURBAN 2WD OFFER AN EPA ESTIMATED MPG 20 HIGHWAY – THAT'S BETTER THAN TOYOTA SEQUOIA, FORD EXPEDITION OR**

**NISSAN ARMADA.<sup>1</sup>** | As always, Suburban is the SUV that can carry people and cargo.

There's seating for nine in LS. Or you can load up the gear with a **CLASS-LEADING 137.4 CU. FT. OF MAXIMUM CARGO CAPACITY.<sup>2</sup>** | Three-quarter-ton models trailer up to 9,600 lbs.<sup>3</sup> | We know families

travel in Suburban every day, so the list of standard safety features includes StabiliTrak and **HEAD-CURTAIN SIDE-IMPACT AIR BAGS FOR ALL ROWS.<sup>4</sup>** OnStar<sup>5</sup> is standard for one year, including Automatic

Crash Response. 2009 half-ton models earned the highest possible rating in recent government frontal and side-impact crash tests – five stars.<sup>6</sup>

<sup>1</sup> Based on latest available competitive information. EPA est. MPG (highway): Suburban 20; Sequoia 19; Expedition 18; Armada 18. <sup>2</sup> Based on 2008 GM Large Utility segment and latest available competitive information. Excludes other GM vehicles. With second-row seats folded and third-row seats removed. Cargo and load capacity limited by weight and distribution. <sup>3</sup> Maximum trailer weight ratings are calculated assuming a base vehicle, except for any option(s) necessary to achieve the rating, plus driver. The weight of other optional equipment, passengers and cargo will reduce the maximum trailer weight your vehicle can tow. See your Chevy dealer for additional details. <sup>4</sup> Always use safety belts and the correct child restraint for your child's age and size. Even in vehicles equipped with the Passenger Sensing System, children are safer when properly secured in a rear seat in the appropriate infant, child or booster seat. Never place a rear-facing infant restraint in the front seat of any vehicle equipped with an active air bag. See the Owner's Manual and child safety seat instructions for more safety information. <sup>5</sup> Call 1-888-4ONSTAR (1-888-466-7827), visit onstar.com and see the inside back cover of this catalog for details and system limitations. <sup>6</sup> Side-impact crash test rating is for a model tested with standard head-curtain side-impact air bags (SABs). Government star ratings are part of the National Highway Traffic Safety Administration's (NHTSA's) New Car Assessment Program (www.safercar.gov).





## SOMETHING FOR THE WHOLE GANG.

Inside and out, Suburban LTZ has it all. | New for 2009 are leather-appointed **HEATED AND COOLED FRONT BUCKET SEATS** that feature 12-way power for the ultimate in comfort. | The heated second-row bucket seats are also leather-appointed, while the third row features a **THREE-PERSON, STADIUM-STYLE BENCH SEAT**. | Behind that seat is an impressive 45.8 cu. ft. of space for your gear.<sup>1</sup> Plus, a **POWER-REMOTE LIFTGATE** makes it easy to access by simply pressing a button on the key fob or overhead console. | The exterior is highlighted by a **SCULPTED, AERODYNAMIC APPEARANCE** and multiple chrome accents. | Other features include 20-inch polished-aluminum wheels;<sup>2</sup> Rainsense wipers with a heated windshield washer fluid system; and heated, power-adjustable and power-folding outside mirrors with integrated turn-signal indicators. | And all this comes standard on a vehicle that offers an **EPA ESTIMATED MPG 20 HIGHWAY FOR 2WD MODELS**.

<sup>1</sup> Cargo and load capacity limited by weight and distribution. <sup>2</sup> Use only GM-approved tire and wheel combinations. For important tire and wheel information, go to [gmaccessorieszone.com](http://gmaccessorieszone.com) or see your dealer for details.

**SECOND-ROW SEATING INNOVATIONS** help deliver high levels of convenience and refinement. Heated seats and a power-release feature are standard in Suburban and Tahoe LTZ and included in 2LT with the available Luxury Package. Just the touch of a button sends the seats into motion, first folding and then tumbling forward. This feature makes it decidedly easier for passengers to enter or exit the third row of seats.



## THE FLEXIBLE ONE.

Your life changes every day. Here's one vehicle that can do the same. | The **GM-EXCLUSIVE MIDGATE HELPS DELIVER UNRIVALED VERSATILITY**<sup>1</sup> by turning Avalanche from an SUV to a full-size pickup with an 8' 2" cargo box<sup>2</sup> in less than a minute. | Then there's the removable three-piece cargo cover, lockable top-box storage and the **LARGEST TRUNK IN THE INDUSTRY**<sup>3</sup> – ready to deliver on Avalanche's promise as the most flexible vehicle out there.<sup>1</sup> | The flexibility continues with your choice of proven



FUEL EFFICIENCY

Vortec V8 engines with Active Fuel Management technology, which helps **AVALANCHE 2WD OFFER AN EPA ESTIMATED MPG 20 HIGHWAY** when running on gasoline. That's something Toyota Tundra Double Cab and Ford F-150 SuperCrew can't match.<sup>4</sup> | There's also an available FlexFuel 5.3L V8 that can run on either unleaded fuel or E85,<sup>5</sup> **FLEXFUEL** E85 ETHANOL a blend of 85% ethanol and 15% gasoline. | And because you never know where the next turn will take you, LT and LTZ models feature OnStar<sup>6</sup> with a standard one-year Directions & Connections Plan that includes **TURN-BY-TURN NAVIGATION**.<sup>7</sup>

1 Based on 2008 GM Large Pickup segment and latest available competitive information. Excludes other GM vehicles. 2 Cargo and load capacity limited by weight and distribution. 3 Based on latest available competitive information of vehicles with lockable trunks separate from the passenger compartment. 4 Based on latest available competitive information. EPA est. MPG (highway): Avalanche 20; Tundra Double Cab 19; F-150 SuperCrew 19. 5 Go to [chevy.com/biofuels](http://chevy.com/biofuels) to see if there is an E85 station near you. 6 Call 1-888-4ONSTAR (1-888-466-7827), visit [onstar.com](http://onstar.com) and see the inside back cover of this catalog for details and system limitations. 7 Not available in certain areas. Visit [onstar.com](http://onstar.com) for coverage maps.





## EMBRACE CHANGE.

By the time you finish reading this page, you could have changed Avalanche from an SUV to a full-size pickup with an 8' 2" **CARGO BOX**.<sup>1</sup> | With the GM-exclusive Midgate, it takes only a minute to see why we call Avalanche the most flexible vehicle out there.<sup>2</sup> | Adaptability is important, but so is security. You can keep your gear safe and out of the elements with the **THREE-PIECE CARGO COVER**, locking tailgate and stationary window. | The **INGENIOUS ELEMENTS** of Avalanche don't stop there. The cargo box was designed to carry items up to 50 inches wide,<sup>1</sup> and it also has a light on the driver side that lets you see what you want to retrieve.

1 Cargo and load capacity limited by weight and distribution. 2 Based on 2008 GM Large Pickup segment and latest available competitive information. Excludes other GM vehicles.



**WITH THE 60/40 SPLIT-FOLDING REAR BENCH SEAT AND MIDGATE UPRIGHT**, every Avalanche (2LT interior shown) is configured as a five-passenger SUV.



**TO BEGIN CONVERTING AVALANCHE** from an SUV to a pickup, simply lower the 60/40 split-folding bench seat. You can also stow the rear window inside the Midgate.



**TO UTILIZE THE FULL LENGTH OF THE CARGO BOX**, just lower the Midgate. You get a completely secured cargo area when the three-piece cargo cover and rear window are in place.



**TO COMPLETE AVALANCHE'S TRANSFORMATION**, remove the rear window and three-piece cargo cover, and lower the tailgate to transport items such as a small ATV.



**WITH THE MIDGATE UPRIGHT**, Avalanche 2LT has the look and feel of an upscale SUV. Custom Leather-appointed seats are standard, as are dual-zone automatic climate controls. Power-adjustable pedals help provide comfort to drivers of various heights. And a six-disc CD changer with an auxiliary audio input lets you customize your listening experience.



**LOWERING THE MIDGATE** brings you the capability of a full-size pickup. Long items such as kayaks and lumber can be transported with ease. Avalanche 2LT 4x4 above in Dark Blue Metallic and below in Victory Red (available for production through December 2008). Both shown with the Light Cashmere/Dark Cashmere interior and available features.



## POWER AND EFFICIENCY. OUR VERSION OF FAMILY VALUES.

**TAHOE.** The Vortec 5.3L V8 engine, standard in LS 4x4 models and all LT and LTZ models, features Active Fuel Management technology that helps balance 320 hp with better fuel economy than any competitor.<sup>1</sup> Standard in Tahoe LS 2WD models, a Vortec 4.8L V8 engine generates 295 horsepower and 305 lb.-ft. of torque. New for 2009, a Vortec 6.2L V8 engine<sup>2</sup> is available for Tahoe LTZ models and kicks out a prodigious 395 horsepower and 417 lb.-ft. of torque.



HYBRID

**TAHOE HYBRID.** A 6.0L V8 engine provides Tahoe Hybrid (at participating dealers only) with the power you expect from a Chevy Truck – 332 horses and 367 lb.-ft. of torque. At the same time it helps 2WD models offer an EPA estimated MPG 21 city, 22 highway, and 4x4 models offer an MPG 20 city, 20 highway.

**SUBURBAN.** In 2WD and 4x4 half-ton models, the Vortec 5.3L V8 engine generates 310 hp, with 2WD models offering an EPA estimated MPG 14 city, 20 hwy. The available Vortec 6.0L V8 in 2LT<sup>3</sup> and LTZ half-ton models creates 366 horsepower and 376 lb.-ft. of torque. The Vortec 6.0L V8 standard in three-quarter-ton models delivers 352 horsepower and 382 lb.-ft. of torque.

**AVALANCHE.** In 2WD and 4x4 models, the Vortec 5.3L V8 engine produces 310 horses, with 2WD models offering an EPA estimated MPG 14 city, 20 highway. The Vortec 6.0L V8 engine available in 2LT<sup>3</sup> and LTZ models delivers 366 horsepower and 376 lb.-ft. of torque.



**TAHOE XFE OFFERS AN ESTIMATED MPG 15 CITY, 21 HIGHWAY (BASED ON GM TESTING).** New for 2009 and available on LS, 1LT and 2LT 2WD models, Tahoe XFE offers better highway fuel economy than any of its competitors, including Toyota Sequoia and Ford Expedition.<sup>4</sup> XFE also features an aluminum block Vortec 5.3L V8 engine and a 3.08 rear axle ratio.

<sup>1</sup> Based on 2008 GM Large Utility segment and latest available competitive information. Tahoe 2WD with available 5.3L V8 EPA est. MPG 14 city, 20 highway. Excludes other GM vehicles. <sup>2</sup> Requires available 3.42 rear axle ratio. <sup>3</sup> Requires available Autoride suspension and heavy-duty locking rear differential. Not available with Z71 Off-Road Package. <sup>4</sup> Available October 2008. Based on 2008 GM Large Utility segment and latest available competitive information. Tahoe XFE estimated MPG 15 city, 21 highway (based on GM testing). EPA est. MPG (city/highway): Sequoia 14/19; Expedition 12/18. Excludes other GM vehicles. <sup>5</sup> Excludes Tahoe Hybrid.

### TAHOE HYBRID PROPULSION SYSTEM



Here's a brief overview of how the two-mode hybrid propulsion system works:

- Mode 1 – In the first mode, at low speeds and with light loads, the vehicle can operate three ways: electric power, engine power or in any combination of electric and engine power. When operating on electric power, with no engine power needed, you receive all the benefits of a full hybrid system.
- Mode 2 – The second mode is used primarily at highway speeds. It provides electric assist in addition to four-cylinder or full eight-cylinder power when driving conditions demand it, such as trailer towing and climbing steep grades.



The addition of a second mode to the drive system reduces the need for large electric motors, which are used in today's single-mode systems. Tahoe Hybrid employs two smaller motors that are lighter and efficiently packaged within the space of its automatic transmission. Shifts between the two modes are synchronous, which means no engine speed changes are necessary for the mode shift to occur. This results in very smooth acceleration for Tahoe Hybrid.

Available at participating dealers only.

### VORTEC 5.3L V8 FLEXFUEL ENGINE



BIOFUELS

Standard in Tahoe<sup>5</sup>, Suburban half-ton and Avalanche 4x4 models and available in those same vehicles for 2WD models, this engine operates on either regular unleaded gasoline; E85 – a blend of 85% ethanol and 15% gasoline; or any combination of both. Because ethanol is made from primarily organic, domestic resources, E85 is a mostly renewable fuel that can help reduce our dependence on petroleum.

- E85 is a cleaner-burning fuel source, which helps reduce smog-forming emissions.
- Plus, E85 generally has a higher octane rating than regular unleaded gasoline, which can result in slightly higher horsepower and torque levels. In fact, when running on E85, the Vortec 5.3L V8 FlexFuel engine generates 326 horsepower and 350 lb.-ft. of torque.
- Chevy has over 2 million E85-capable FlexFuel vehicles on the road today.
- Go to [chevy.com/biofuels](http://chevy.com/biofuels) to see if there is an E85 station near you.

### ACTIVE FUEL MANAGEMENT



FUEL EFFICIENCY

With Active Fuel Management technology from GM on the available Vortec 5.3L V8 engine (Tahoe, Suburban half-ton and Avalanche) and on the available Vortec 6.0L V8 engine (Suburban half-ton and Avalanche only), power is delivered when you need it. In situations where extra power is not needed, such as cruising down the highway on level roads, Active Fuel

Management deactivates four of the eight cylinders with seamless precision. When load demands increase, such as when the vehicle accelerates or travels uphill, cylinders are reactivated to provide eight-cylinder operation.

Active Fuel Management technology helps Tahoe, Suburban half-ton and Avalanche models

equipped with the Vortec 5.3L V8 engine offer an EPA estimated MPG 14 city, 20 highway for 2WD models. Tahoe 4x4 offers those same impressive numbers. That means a driving range of up to 520 highway miles on a single tank of gas in Tahoe 2WD and 4x4 and 620 highway miles in Suburban half-ton 2WD and Avalanche 2WD models. When running on E85, this engine has an EPA estimated MPG 11 city, 15 highway for 2WD models and 11 city, 14 highway for Tahoe 4x4 models.

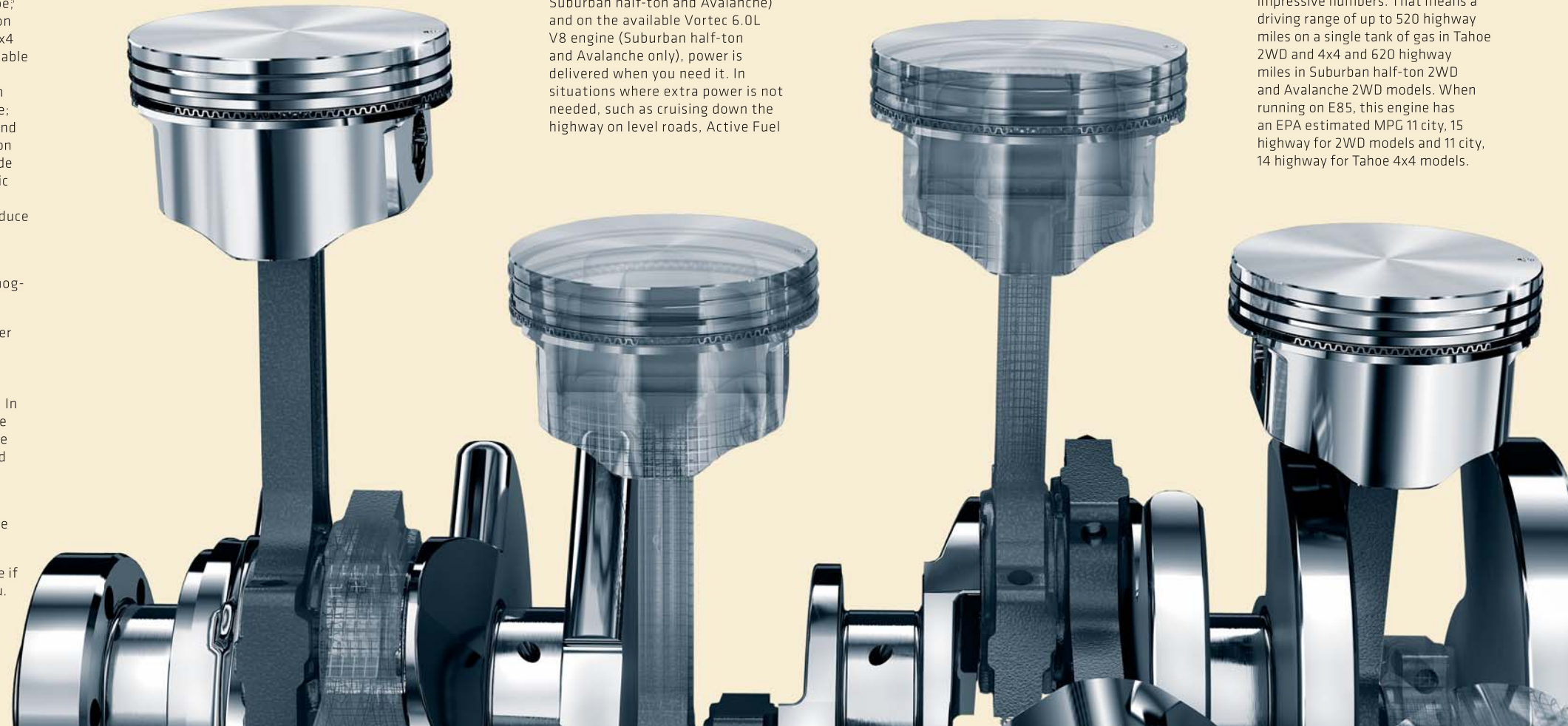

# TRAILERING BASICS

**NOTE:** Towing a trailer involves all major vehicle systems of your Chevy Truck. Easy and safe trailering requires a properly equipped vehicle, additional trailering equipment and an appropriate trailer. It also requires loading both the vehicle and trailer properly, using safe driving techniques, meeting regional legal requirements, and following break-in and maintenance schedules. For more information, consult your Owner's Manual, speak to a trailering expert at your Chevrolet dealership or visit our web site at [chevy.com](http://chevy.com). To help you better understand trailering, consider these trailering factors:

**RGAWR AND GVWR:** Addition of trailer hitch weight cannot cause vehicle weights to exceed Rear Gross Axle Weight Rating (RGAWR) or Gross Vehicle Weight Rating (GVWR). These ratings can be found on the certification label located on the driver door or doorframe.

**GCWR:** The Gross Combination Weight Rating is the total allowable weight of the completely loaded vehicle and trailer.

**MAXIMUM TRAILER RATING:** This rating is determined by subtracting the tow vehicle's weight (curb weight) from the GCWR. When a base vehicle (curb) weight is used, additional passenger, equipment and cargo weight reduce this rating.

**NOTE:** The safety steps described here are by no means the only precautions to be taken when trailering. See the Owner's Manual for your Chevy vehicle for additional guidelines and trailering tips.

**TRAILERING CAUTION:** If you don't use the correct equipment and drive properly, you can lose control of your vehicle when you pull a trailer. If the trailer is too heavy, your vehicle brakes may be less effective. You and your passengers could be seriously injured. Pull a trailer only after you have taken the following steps.

**TRAILER BRAKES:** If your trailer weighs more than 2,000 lbs. loaded, then it must have its own adequate brakes. Be sure to read and follow the instructions for the trailer brake controller so that it is installed, adjusted and maintained properly. ■ Don't tap into your vehicle's brake system.

**HITCHES:** It's important to have the correct hitch equipment. ■ If you'll be towing a trailer that, when loaded, will weigh more than 5,000 lbs., be sure to use a frame-mounted, weight-distributing hitch and sway control of the proper size. ■ If you have to make any holes in the body of your vehicle to install a trailer hitch, be sure to seal the holes if you ever remove the hitch. If they're not sealed, dirt, water and deadly carbon monoxide from the exhaust can get into your vehicle.

<sup>1</sup> Maximum trailer weight rating may be less, based upon powertrain combination.

Weight-carrying hitch limit: 5,000-lb. trailer with 600-lb. tongue weight. Weight-distributing hitch and sway control required over 5,000-lb. trailer weight. The vehicle owner is responsible for obtaining the hitch ball; a hitch of the proper size, type, and capacity; and other appropriate equipment required to safely tow both the trailer and the load that will be towed. Ask your Chevrolet dealer for advice about the proper trailering equipment for your new vehicle.

## SUBURBAN TRAILERING/HAULING SPECIFICATIONS

VORTEC 5.3L V8 (HALF-TON)	MAX. PAYLOAD <sup>1</sup> (LBS.)	MAX. TRAILER WEIGHT <sup>2</sup>	REQUIRED AXLE RATIO	GCWR <sup>3</sup> (LBS.)
2WD	1513	5100/8100 <sup>4</sup>	3.08/3.42 <sup>4</sup>	11,000/14,000 <sup>4</sup>
4x4	1564	5400/7900 <sup>4</sup>	3.42	11,500/14,000 <sup>4</sup>
VORTEC 6.0L V8 (HALF-TON)				
2WD	1559	8100	3.42	14,000
4x4	1535	7900	3.42	14,000
VORTEC 6.0L V8 (THREE-QUARTER-TON)				
2WD	2421	9600	3.73	16,000
4x4	2153	9300	3.73	16,000

## TAHOE TRAILERING/HAULING SPECIFICATIONS

VORTEC 4.8L V8	MAX. PAYLOAD <sup>1</sup> (LBS.)	MAX. TRAILER WEIGHT <sup>2</sup>	REQUIRED AXLE RATIO	GCWR <sup>3</sup> (LBS.)
2WD	1838	4500/4800	3.23/3.73	10,000
VORTEC 5.3L V8				
2WD	1775	5400/8400 <sup>4</sup>	3.08/3.42 <sup>4</sup>	11,000/14,000 <sup>4</sup>
4x4	1704	5700/8200 <sup>4</sup>	3.42	11,500/14,000 <sup>4</sup>
VORTEC 6.0L V8 (HYBRID ONLY)				
2WD	1485	6200	3.08	12,000
4x4	1455	6000	3.08	12,000
VORTEC 6.2L V8				
2WD	1883	8500	3.42	14,000
4x4	1696	8100	3.42	14,000

## AVALANCHE TRAILERING/HAULING SPECIFICATIONS

VORTEC 5.3L V8 (HALF-TON)	MAX. PAYLOAD <sup>1</sup> (LBS.)	MAX. TRAILER WEIGHT <sup>2</sup>	REQUIRED AXLE RATIO	GCWR <sup>3</sup> (LBS.)
2WD	1332	5100/8100 <sup>4</sup>	3.08/3.42 <sup>4</sup>	11,000/14,000 <sup>4</sup>
4x4	1433	5500/7900 <sup>4</sup>	3.42	11,500/14,000 <sup>4</sup>
VORTEC 6.0L V8 (HALF-TON)				
2WD	1375	8100	3.42	14,000
4x4	1349	7700	3.42	14,000

<sup>1</sup> Cargo and load capacity limited by weight and distribution. Maximum payload capacity includes weight of driver, passengers, optional equipment and cargo. <sup>2</sup> Maximum trailer weight ratings are calculated assuming a base vehicle, except for any option(s) necessary to achieve the rating, plus driver. The weight of other optional equipment, passengers and cargo will reduce the maximum trailer weight your vehicle can tow. See your Chevy dealer for additional details. <sup>3</sup> Gross Combination Weight Rating (GCWR) is the total allowable weight of completely loaded vehicle and trailer. <sup>4</sup> Requires available Heavy-Duty Trailering Package. NOTE: Trailer tongue weight should be 10 to 15 percent of total loaded trailer weight (up to 1,000 lbs.). Addition of tongue weight cannot cause vehicle weights to exceed Rear Gross Axle Weight Rating (RGAWR) or Gross Vehicle Weight Rating (GVWR). These ratings can be found on the certification label located on the driver door or doorframe.

TAHOE | SUBURBAN | AVALANCHE



Suburban three-quarter-ton LT in Deep Ruby Metallic with available Chevy Accessories and other features.

For more information, go to [chevy.com](http://chevy.com)



## Z71. THE ADVENTUROUS ONE.

**Z71** “Go outside and play” is not just for kids anymore. | All-terrain ability is at your command with the **Z71 OFF-ROAD PACKAGE** available on all Tahoe, Suburban and Avalanche 2LT models. | The package features the legendary Z71 suspension, which combines with **HIGH-PRESSURE, GAS-CHARGED MONOTUBE SHOCKS**, a durable Skid Plate Package and rugged 18-inch wheels with on-/off-road tires to help take on the rough stuff. | An **AUTOMATIC LOCKING REAR DIFFERENTIAL** kicks in when you need extra grip on sand, mud or snow. | 4x4 models feature the Autotrac system. | A Z71-specific front fascia with rectangular foglamps and a bright chrome grille insert pairs with massive wheel flares and satin-chrome tubular assist steps to ensure that all this capability is complemented by a distinctive appearance.



**INSIDE Z71**, leather-appointed seats are standard in Ebony, Light Cashmere or Light Titanium. A brushed metal appearance on the instrument panel, center stack, steering wheel and door panels provides a one-of-a-kind look. And a Z71-specific gauge cluster helps round out the package. Interior shown with leather-appointed Light Cashmere seating and available features.

A **REAR CAMERA DISPLAY** is designed to allow the driver to see certain stationary objects located behind the vehicle when traveling in reverse at low speeds. The viewing screen is positioned intuitively in the rearview mirror so that you can see the display and the mirror reflection simultaneously. The display appears automatically when the vehicle is in Reverse and disappears once the vehicle is put in Drive. Available on LS, 1LT and 2LT models.



<sup>1</sup> Requires available Convenience Package on LS and 1LT; requires available rearview camera system on 2LT.



## AN EAR FOR SOUND. AN EYE FOR ENTERTAINMENT.

LTZ presents a feast for the senses. Let's start with your ears. | **BOSE® CENTERPOINT® SURROUND SOUND SYSTEM** creates a 360-degree listening experience from ordinary stereo CDs, MP3 CDs, and satellite radio, while **BOSE® SURROUNDSTAGE®** is customized to the vehicle so that every listener feels as though they're in the middle of the music. | March to your own drummer with an **AUXILIARY AUDIO INPUT JACK** for an iPod® device. | Three trial months of XM Radio<sup>1</sup> are standard with every model. | Moving on to the eyes, an available **TOUCH-SCREEN NAVIGATION RADIO<sup>2</sup>** includes a 6.5-inch-diagonal color display and voice recognition. | If your vehicle is equipped with a navigation radio, available **XM NAVTRAFFIC<sup>3</sup>** enhances the system by showing real-time traffic data when you need it most – while you're driving. Available in over 80 markets, XM NavTraffic displays construction, road closures and accidents so you can get to your destination faster. Learn more at [gm.xmradio.com/navtraffic](http://gm.xmradio.com/navtraffic).

1 XM is available only in the 48 contiguous United States. Required \$12.95 monthly subscription sold separately after three trial months. All fees and programming subject to change. Visit [gm.xmradio.com](http://gm.xmradio.com) for more details. 2 Requires available rearview camera system. Map coverage not available in Puerto Rico, the Virgin Islands and portions of Canada. 3 Requires available navigation radio. Required XM Radio and XM NavTraffic monthly subscriptions sold separately after trial period. XM NavTraffic only available in select markets. All fees and programming subject to change. Subscriptions subject to customer agreement available at [gm.xmradio.com](http://gm.xmradio.com). XM service only available in the 48 contiguous United States. 4 The Bluetooth word mark is a registered trademark owned by Bluetooth SIG, Inc. and any use of such mark by Chevrolet is under license. Go to [gm.com/bluetooth](http://gm.com/bluetooth) to find out which Bluetooth phones are compatible with the vehicle. 5 Requires available Bose sound system in 1LT and 2LT. Requires available automatic climate controls in 1LT. 6 Requires available navigation radio in LTZ; requires available navigation radio or inside rearview mirror with rear camera display in 2LT; requires available Convenience Package in LS and 1LT. iPod is a mobile digital device. iPod is a registered trademark of Apple, Inc. All rights reserved.



**WITH BLUETOOTH® WIRELESS TECHNOLOGY** for select compatible phones standard on every 2009 Tahoe, Suburban and Avalanche, you can answer and end calls without touching your mobile phone – because now most Bluetooth-compatible cell phones<sup>4</sup> can be paired to the vehicle. In addition, as an incoming call is answered, the vehicle's audio system is conveniently and automatically muted.



**BRING THE ENTERTAINMENT ALONG.** Available in all LT and LTZ models, the DVD entertainment system<sup>5</sup> has an eight-inch-diagonal monitor, two wireless headphones, and the ability to play video from your iPod. Newly available in Suburban for 2009 is a second monitor positioned between the second and third rows.



**AN AVAILABLE REARVIEW CAMERA SYSTEM<sup>6</sup>** helps the driver see certain stationary obstacles on the navigation screen (shown) or rearview mirror while moving in reverse at low speeds.

## BEING OVERPROTECTIVE IS OUR BIRTHRIGHT.



FIVE-STAR FRONTAL AND SIDE-IMPACT CRASH TEST RATINGS<sup>1</sup>

**SIDE BLIND ZONE ALERT** uses alternating beams of radar, emanating from behind the lower portion of the rear quarter panels, to sweep adjacent lanes of traffic in 150-degree arcs. The system then provides a visual warning in the corresponding outside rearview mirror to alert you to vehicles entering those zones from either the rear or the side. So when you check that mirror, even if the vehicle isn't visible, you'll know it's there. The system is designed to ignore most stationary objects and work at all speeds in most kinds of weather. Available on Tahoe and Suburban LTZ.



**HEAD-CURTAIN SIDE-IMPACT AIR BAGS** Standard on all models, head-curtain side-impact air bags<sup>2</sup> help reduce the risk of injuries to all outboard occupants in certain side impacts. These air bags cover all rows and are designed to stay inflated in the unlikely event of a rollover to help reduce the risk of ejection.

**STABILITRAK ELECTRONIC STABILITY CONTROL SYSTEM** Standard on every model, this system helps improve vehicle stability, particularly during emergency maneuvers. The system also includes Proactive Roll Avoidance, which reduces a vehicle's tendency to roll over in an emergency situation. Visit [chevy.com](http://chevy.com) for more information on how StabiliTrak works.

**FIVE-STAR RATINGS** All Tahoe and Avalanche models as well as Suburban half-ton models earned the highest possible rating for frontal and side-impact crash tests – five stars.<sup>1</sup>

**FOUR-WHEEL ANTILOCK DISC BRAKES** All Tahoe and Avalanche models as well as Suburban half-ton models feature a two-

piston front and single-piston rear brake design for reduced noise and an active brake booster system for enhanced pedal feel with reduced noise. Nonasbestos organic brake linings help extend brake life with normal use.<sup>3</sup>

**TIRE PRESSURE MONITOR** This system is standard in every Tahoe, Suburban and Avalanche and monitors the tire inflation level in each of the four road tires. If any tire falls below a specified pressure, the driver is alerted via a message on the Driver Information Center (DIC). That's important because properly inflated tires can improve gas mileage by up to three percent.<sup>4</sup>

**THE BEST COVERAGE IN AMERICA** Every Tahoe, Suburban and Avalanche is covered by the Chevy 100,000 mile/5-year<sup>5</sup> Transferable Powertrain Limited Warranty plus Roadside Assistance and Courtesy Transportation. In addition, GM will also warrant certain hybrid components on Tahoe Hybrid models for 100,000 miles/8 years.<sup>5</sup>

<sup>1</sup> Side-impact crash test rating is for a model tested with standard head-curtain side-impact air bags (SABs). Government star ratings are part of the National Highway Traffic Safety Administration's (NHTSA's) New Car Assessment Program ([www.safercar.gov](http://www.safercar.gov)). <sup>2</sup> Always use safety belts and the correct child restraint for your child's age and size. Even in vehicles equipped with the Passenger Sensing System, children are safer when properly secured in a rear seat in the appropriate infant, child or booster seat. Never place a rear-facing infant restraint in the front seat of any vehicle equipped with an active air bag. See the Owner's Manual and child safety seat instructions for more safety information. <sup>3</sup> Maintenance needs vary with different uses and driving conditions. See the Owner's Manual for more information. <sup>4</sup> Source: [fuelconomy.gov](http://fuelconomy.gov). <sup>5</sup> Whichever comes first. See dealer for details.



## ONSTAR

 A one-year OnStar<sup>1</sup> Safe & Sound Plan is standard in LS models, while the Directions & Connections Plan is standard in LT and LTZ models, as well as in Tahoe Hybrid (at participating dealers only).

**ONSTAR TURN-BY-TURN NAVIGATION<sup>2</sup>** Included in the Directions & Connections Plan, this is the simplest and smartest navigation system. Just press the OnStar button and tell the Advisor where you want to go. The Advisor will download the directions to your vehicle and an automated voice will guide you through every turn until you arrive at your destination. Turn-by-Turn Navigation makes stopping to ask for directions and fumbling with maps things of the past. And Turn-by-Turn allows you to keep your eyes on the road and your hands on the wheel.

**ENAV<sup>3</sup>** This OnStar feature provides the ability to preplan trips as it allows an eligible subscriber with a Turn-by-Turn Navigation<sup>2</sup>-capable vehicle to find and save destinations on MapQuest.com. Simply look for the OnStar link on your maps and directions results page on MapQuest.com. Then you can skip the printer as those destinations are sent directly to the vehicle.

**DESTINATION DOWNLOAD** New for 2009 is Destination Download, the simplest way to input locations into a screen-based navigation system. A subscriber with the appropriate navigation system simply presses the blue OnStar button to connect with an Advisor, provides a location and waits just a few seconds as the destination is downloaded to their screen. There's never the need to stop and enter the location.

**ONSTAR VEHICLE DIAGNOSTICS** Each month, your vehicle automatically runs hundreds of diagnostic checks of its key operating systems (i.e., engine, transmission, emissions, ABS, air bags, oil life and tire pressure) and sends you an easy-to-read email summary. This helps deliver the confidence that your vehicle is ready to go and keeps you apprised of your vehicle's maintenance needs. At any point between your monthly emails, you can press the blue OnStar button for an immediate check of the vehicle's key operating systems.



 **STOLEN VEHICLE LOCATION ASSISTANCE AND STOLEN VEHICLE SLOWDOWN** If you've reported your vehicle stolen, OnStar uses GPS technology to pinpoint the location of your stolen vehicle.<sup>4</sup> Vehicle location is provided to law enforcement officials to assist them with the vehicle's quick recovery.

In select models, OnStar can also assist authorities by remotely slowing down a stolen vehicle. Once authorities have a clear line of sight of the vehicle and confirm that conditions are safe, they can request OnStar to send a remote signal to gradually slow down the stolen vehicle. Stolen Vehicle Slowdown<sup>SM</sup> helps reduce the risk of property damage, injuries or fatalities resulting from high-speed pursuits. Not available on Tahoe Hybrid.

 **HANDS-FREE CALLING** With this feature, there's no need to worry about handling a cell phone while driving. Hands-Free Calling<sup>5</sup> lets you keep your hands on the wheel and your eyes on the road, with only the push of a button and simple voice commands needed to make or receive calls. You'll also have peace of mind knowing that even when your cell phone is unavailable or the battery is low, you can still be in touch on the road.

 **REMOTE DOOR UNLOCK** If you are locked out of your vehicle, just make one simple, toll-free call to an OnStar Advisor, and a remote signal will be sent to quickly unlock your doors.<sup>6</sup>

 **AUTOMATIC CRASH RESPONSE** If you're involved in a collision, built-in vehicle sensors can automatically send a signal to OnStar. An Advisor is immediately connected into your vehicle to see if you and your passengers are okay.

<sup>1</sup> Call 1-888-4ONSTAR (1-888-466-7827), visit onstar.com and see the inside back cover of this catalog for details and system limitations. OnStar acts as a link to emergency service providers. <sup>2</sup> Not available in certain areas. Visit onstar.com for coverage maps. <sup>3</sup> Not available in certain areas and with Verizon Wireless Nationwide Plan with OnStar. Visit onstar.com for coverage map. <sup>4</sup> Ability to locate stolen vehicles varies with conditions. <sup>5</sup> Hands-Free Calling requires a Hands-Free Calling-enabled vehicle, existing OnStar service contract and prepaid minutes or enrollment in a shared minutes plan. Not available in certain markets. Calls may be made to the U.S. and Canada only. <sup>6</sup> Remote Door Unlock success varies with conditions.



Tahoe LT 4x4 in Black with available dealer-installed Ground Effects Package, billet grille, fender flares, D22 wheels<sup>1</sup> and chrome fuel door, mirror caps and door handles from Chevy Accessories.

## ACCESSORIES

All dealer-installed **CHEVY ACCESSORIES** have been engineered specifically for Tahoe, Suburban or Avalanche. | So we have the confidence to back them all with the GM 3-year/36,000-mile (whichever comes first) New Vehicle Limited Warranty when they are ordered with your truck. | Accessories installed after delivery include a 12-month/12,000-mile (whichever comes first) limited warranty. Accessories not requiring installation or purchased over the counter carry a 12-month warranty (parts only). | Plus, all accessories can be included in your monthly payment. | See your dealer for warranty details, and head to [chevy.com](http://chevy.com) to find even more ways to personalize your vehicle.



 **D20 AND D22 WHEELS** These premium, cast chrome wheels were designed in conjunction with the team that brought you *DUB Magazine*. They are packaged with center caps that feature the D20 or D22 logo and are sold exclusively through GM dealers nationwide. They require specific tires.

<sup>1</sup> Use only GM-approved tire and wheel combinations. Unapproved combinations may change the vehicle's performance characteristics. For approved tire and wheel combinations and other important information, go to [gmaccessorieszone.com](http://gmaccessorieszone.com) or see your dealer for details.

For more information, go to [chevy.com](http://chevy.com)



**TWO-WAY ADVANCED REMOTE START.** Two-way technology and a convenient display shows the vehicle's current status (e.g., locked or remote-start engaged) and critical vehicle data, including tire air pressure, fuel level and theft-alarm status. This fob offers greater operating range than the factory keyless entry system and can control a second, Advanced Remote Vehicle Start-equipped vehicle.



**FRONT FLOOR CONSOLE ORGANIZER** transforms this easily accessible bin into a highly useful two-tier compartment.



**PORTABLE DVD PLAYER** helps entertain rear-seat passengers on the road and can be easily removed from the vehicle when you stop.<sup>1</sup>



**A POWER TONNEAU COVER,** available for Avalanche, opens and closes with the touch of a button to improve rear cargo area access.



**A STAINLESS STEEL EXHAUST TIP** adds a custom appearance to your vehicle's exterior. For use only with the standard exhaust system.

**HEAD RESTRAINT DVD SYSTEM** features two seven-inch-diagonal, flat-screen monitors and two top-loading DVD/CD/MP3 players. Available for leather-appointed or cloth seats.



**20-INCH CHROME WHEELS<sup>2</sup>** are available in five-, six- and 12-spoke designs and are the ideal way to make your vehicle stand out.



**22-INCH CHROME WHEELS<sup>2</sup>** are, quite simply, the crown jewels of the Chevy Accessory lineup.

<sup>1</sup> Available docking station sold separately. <sup>2</sup> Also available as dealer-ordered accessory options. Use only GM-approved tire and wheel combinations. Unapproved combinations may change the vehicle's performance characteristics. For approved tire and wheel combinations and other important information, go to [gmaccessorieszone.com](http://gmaccessorieszone.com) or see your dealer for details.

**AVALANCHE LTZ 4X4** in Blue Granite Metallic. Shown with available dealer-installed brush grille guard, Cross Rail Package, tubular assist steps, 20-inch chrome wheels<sup>2</sup> and chrome fuel door from Chevy Accessories.



**SUBURBAN LT 4X4** in Black. Shown with available dealer-installed tubular assist steps, chrome mesh billet grille, chrome recovery hooks, chrome mirror caps and door handles, 20-inch chrome wheels<sup>2</sup> and chrome fuel door from Chevy Accessories.





## SEATS.

**01 PERFORATED LEATHER-APPOINTED FRONT BUCKET SEAT**  
Standard in LTZ models. Shown in Light Cashmere. Also available in Light Titanium and Ebony.

**02 CUSTOM LEATHER-APPOINTED FRONT BUCKET SEAT**  
Standard in 2LT and Hybrid models. Hybrid seats are thin-profile. Shown in Light Titanium. Also available in Light Cashmere and Ebony.

**03 PREMIUM CLOTH FRONT SEAT**  
Standard in LS and 1LT models. LS features a 40/20/40 split-bench seat; 1LT features standard front bucket seats. Shown in Ebony. Also available in Light Titanium and Light Cashmere.

**IMPORTANT INFORMATION**  
Standard in all Chevy Tahoe, Suburban and Avalanche models, the LATCH (Lower Anchors and Top tethers for CHildren) system makes it easier to install child safety seats. LATCH-equipped seating positions have three anchors – a top tether anchor and two lower anchors located between the vehicle's seat cushion and seatback. LATCH-equipped child safety seats have a lower set of attachments that fasten to the vehicle lower anchors. Most forward-facing child safety seats also have a top strap (or tether) that attaches to a top tether anchor. Learn more about how this system works, which seating positions feature LATCH, and where to place child seats in your Tahoe, Suburban or Avalanche at [chevy.com/safety](http://chevy.com/safety).



01

02

03

## WHEELS.



**01 20-INCH POLISHED-ALUMINUM<sup>1</sup>**  
Standard on LTZ; Available on 1LT and 2LT<sup>2</sup>

**02 18-INCH ALUMINUM**  
Standard on Tahoe Hybrid<sup>3</sup>

**03 20-INCH CHROME-CLAD<sup>1</sup>**  
Available on LTZ

**04 18-INCH ALUMINUM**  
Included with Tahoe XFE<sup>4</sup> and Z71 Off-Road Package

**05 16-INCH FORGED-ALUMINUM**  
Standard on Suburban three-quarter-ton

**06 17-INCH ALUMINUM**  
Standard on LS, 1LT and 2LT<sup>2</sup>

**07 17-INCH ALUMINUM**  
Available on Suburban three-quarter-ton

<sup>1</sup> Use only GM-approved tire and wheel combinations. For important tire and wheel information, go to [gmaccessorieszone.com](http://gmaccessorieszone.com) or see your dealer for details. <sup>2</sup> Not available on 2LT with available Z71 Off-Road Package. <sup>3</sup> There is no jack or spare tire in Tahoe Hybrid. See the inside back cover of this catalog for more information. <sup>4</sup> Available October 2008.

## EXTERIOR COLORS.

### TAHOE, SUBURBAN AND AVALANCHE



DARK BLUE METALLIC<sup>1</sup>

SUMMIT WHITE

GOLD MIST METALLIC<sup>1</sup>

BLUE GRANITE METALLIC

GRAYSTONE METALLIC<sup>1</sup>

DEEP RUBY METALLIC<sup>2</sup>

SILVER BIRCH METALLIC

BLACK

### AVALANCHE ONLY



VICTORY RED<sup>3</sup>

INFERNO ORANGE METALLIC<sup>4</sup>

### TAHOE, SUBURBAN AND AVALANCHE LTZ ONLY



WHITE DIAMOND TRICOAT  
(EXTRA-COST COLOR)

RED JEWEL TINTCOAT  
(EXTRA-COST COLOR)

<sup>1</sup> Not available on Z71 or Tahoe Hybrid. <sup>2</sup> Not available on Tahoe and Suburban LTZ. <sup>3</sup> Available for production through December 2008. <sup>4</sup> Available for production starting January 2009.

## SELECT AVALANCHE FEATURES. For a complete list, go to [chevy.com/avalanche/features](http://chevy.com/avalanche/features).

### AVALANCHE LS

- Three-piece cargo cover
- Integrated, top-box storage
- 17-inch aluminum wheels
- Vortec 5.3L V8 with Active Fuel Management
- Six-speed automatic transmission
- Premium Cloth 40/20/40 split-folding front-row bench seat
- Premium Cloth 60/40 split-folding rear bench seat
- Head-curtain side-impact air bags<sup>1</sup>
- OnStar<sup>2</sup> with one-year Safe & Sound Plan
- StabiliTrak Electronic Stability Control System
- Bluetooth<sup>®</sup> wireless technology for select compatible phones<sup>3</sup>
- XM Radio<sup>4</sup> with three trial months

### Popular available features:

- Convenience Package: includes power-adjustable pedals, remote vehicle starter system, Ultrasonic Rear Parking Assist, rearview camera system and inside rearview mirror with rear camera display
- Automatic locking rear differential

### AVALANCHE 1LT

*In addition to or replacing LS features, 1LT includes:*

- Body-color door handles
- Foglamps
- Heated, body-color, power-adjustable outside mirrors
- Premium Cloth front-row bucket seats with floor console
- OnStar<sup>2</sup> with one-year Directions & Connections Plan, including Turn-by-Turn Navigation<sup>5</sup>
- Rear audio controls

### Popular available features:

- Convenience Package: see LS features for details
- Power sunroof<sup>6</sup>
- Rear-seat DVD entertainment system<sup>7</sup>
- 20-inch polished-aluminum wheels<sup>8</sup>
- Universal Home Remote<sup>9</sup>
- Touch-screen navigation radio<sup>10</sup>
- Bose<sup>®</sup> sound system
- Automatic locking rear differential

### AVALANCHE 2LT

*In addition to or replacing 1LT features, 2LT includes:*

- Ultrasonic Rear Parking Assist
- Custom Leather-appointed front-row bucket seats
- Custom Leather-appointed 60/40 split-folding second-row bench seat
- Dual-zone automatic climate controls
- Power-adjustable pedals
- Remote vehicle starter system
- Universal Home Remote
- Six-disc CD/MP3 changer and auxiliary audio input jack

### Popular available features:

- Z71 Off-Road Package, including automatic locking rear differential
- Touch-screen navigation radio<sup>10</sup>
- Bose<sup>®</sup> sound system
- 20-inch polished-aluminum wheels<sup>8</sup>
- Power sunroof
- Rear-seat DVD entertainment system<sup>7</sup>
- Rearview camera system<sup>11</sup>

### AVALANCHE LTZ

*In addition to or replacing 2LT features, LTZ includes:*

- Chrome-capped, power-folding, heated outside mirrors with ground illumination and more
- Roof-mounted luggage rack side rails
- 20-inch polished-aluminum wheels<sup>8</sup>
- Heated washer fluid system
- Rainsense front wipers
- Automatic locking rear differential
- Autoride suspension
- Heated and cooled perforated leather-appointed front-row bucket seats with 12-way power
- Bose<sup>®</sup> Centerpoint<sup>®</sup> Surround Sound system

### Popular available features:

- Power sunroof
- Touch-screen navigation radio<sup>10</sup>
- Rear-seat DVD entertainment system<sup>7</sup>
- Power-articulating side steps<sup>12</sup>
- 20-inch chrome-clad wheels<sup>8</sup>
- Rearview camera system<sup>12</sup>

### AVALANCHE DIMENSIONS

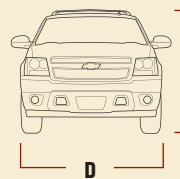
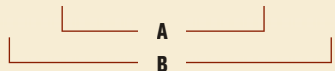

**A = 130.0"**  
**B = 221.3"**  
**C = 73.8" to 76.6" (2WD)**  
**74.1" to 76.8" (4x4)**  
**D = 68.2"**

## SELECT SUBURBAN FEATURES. For a complete list, go to [chevy.com/suburban/features](http://chevy.com/suburban/features).

### SUBURBAN LS

- 17-inch aluminum wheels (half-ton)
- 16-inch polished forged-aluminum wheels (three-quarter-ton)
- Vortec 5.3L V8 with Active Fuel Management (half-ton)
- Vortec 6.0L V8 (three-quarter-ton)
- Six-speed automatic transmission
- Premium Cloth nine-passenger bench seating
- Head-curtain side-impact air bags<sup>1</sup>
- OnStar<sup>2</sup> with one-year Safe & Sound Plan
- StabiliTrak Electronic Stability Control System
- Bluetooth<sup>®</sup> wireless technology for select compatible phones<sup>3</sup>
- XM Radio<sup>4</sup> with three trial months

### Popular available features:

- Convenience Package: includes power-adjustable pedals, remote vehicle starter system, Ultrasonic Rear Parking Assist, rearview camera system and inside rearview mirror with rear camera display
- Automatic locking rear differential

### SUBURBAN 1LT

*In addition to or replacing LS features, 1LT includes:*

- Body-color door handles
- Foglamps
- Heated, body-color, power-adjustable outside mirrors
- Premium Cloth front-row bucket seats with floor console
- OnStar<sup>2</sup> with one-year Directions & Connections Plan, including Turn-by-Turn Navigation<sup>5</sup>
- Rear audio controls

### Popular available features:

- Convenience Package: see LS features for details
- Power sunroof<sup>6</sup>
- Rear-seat DVD entertainment system<sup>7</sup>
- Third-row DVD screen<sup>8</sup>
- 20-inch polished-aluminum wheels<sup>9</sup>
- Tri-zone automatic climate controls<sup>10</sup>
- Universal Home Remote<sup>11</sup>
- Touch-screen navigation radio<sup>12</sup>
- Bose<sup>®</sup> sound system
- Automatic locking rear differential

### SUBURBAN 2LT

*In addition to or replacing 1LT features, 2LT includes:*

- Ultrasonic Rear Parking Assist
- Custom Leather-appointed front-row bucket seats
- Custom Leather-appointed second-row bench seat
- Tri-zone automatic climate controls
- Power-adjustable pedals
- Remote vehicle starter system
- Universal Home Remote<sup>11</sup>
- Six-disc CD/MP3 changer and auxiliary audio input jack

### Popular available features:

- Z71 Off-Road Package, including automatic locking rear differential
- Touch-screen navigation radio<sup>12</sup>
- Bose<sup>®</sup> sound system
- 20-inch polished-aluminum wheels<sup>9</sup>
- Power sunroof<sup>6</sup>
- Rear-seat DVD entertainment system<sup>7</sup>
- Third-row DVD screen<sup>8</sup>
- Second-row bucket seats
- Rearview camera system<sup>13</sup>

### SUBURBAN LTZ

*In addition to or replacing 2LT features, LTZ includes:*

- Power-remote liftgate
- Chrome-capped, power-folding, heated outside mirrors with ground illumination and more
- 20-inch polished-aluminum wheels<sup>9</sup>
- Heated washer fluid system
- Rainsense front wipers
- Automatic locking rear differential
- Autoride suspension
- Heated and cooled perforated leather-appointed front-row bucket seats with 12-way power
- Heated second-row seats with power-release functionality
- Bose<sup>®</sup> Centerpoint<sup>®</sup> Surround Sound system

### Popular available features:

- Power sunroof
- Touch-screen navigation radio<sup>12</sup>
- Rear-seat DVD entertainment system<sup>7</sup>
- Third-row DVD screen<sup>8</sup>
- Power-articulating side steps<sup>14</sup>
- Side Blind Zone Alert
- 20-inch chrome-clad wheels<sup>9</sup>

### SUBURBAN DIMENSIONS

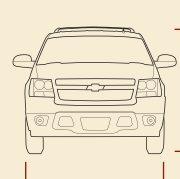
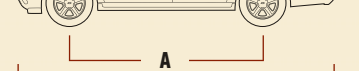

**A = 130.0"**  
**B = 222.4"**  
**C = 74.1" to 76.8" (2WD)**  
**74.1" to 76.8" (4x4)**  
**D = 68.2"**  
**E = 67.0"**

<sup>1</sup> Always use safety belts and the correct child restraint for your child's age and size. Even in vehicles equipped with the Passenger Sensing System, children are safer when properly secured in a rear seat in the appropriate infant, child or booster seat. Never place a rear-facing infant restraint in the front seat of any vehicle equipped with an active air bag. See the Owner's Manual and child safety seat instructions for more safety information. <sup>2</sup> Call 1-888-4ONSTAR (1-888-466-7827), visit [onstar.com](http://onstar.com) and see the inside back cover of this catalog for details and system limitations. <sup>3</sup> The Bluetooth word mark is a registered trademark owned by Bluetooth SIG, Inc. and any use of such mark by Chevrolet is under license. Go to [gm.com/bluetooth](http://gm.com/bluetooth) to find out which Bluetooth phones are compatible with the vehicle. <sup>4</sup> XM is available only in the 48 contiguous United States. Required \$12.95 monthly subscription sold separately after three trial months. All fees and programming subject to change. Visit [gm.xradio.com](http://gm.xradio.com) for more details. <sup>5</sup> Not available in certain areas. Visit [onstar.com](http://onstar.com) for coverage maps. <sup>6</sup> Requires available dual-zone automatic climate controls and Universal Home Remote. <sup>7</sup> Requires available Bose sound system in 1LT and 2LT. Requires available dual-zone automatic climate controls in 1LT. <sup>8</sup> Use only GM-approved tire and wheel combinations. For important tire and wheel information, go to [gmaccessorieszone.com](http://gmaccessorieszone.com) or see your dealer for details. <sup>9</sup> Requires available power sunroof and dual-zone automatic climate controls. <sup>10</sup> Requires available rearview camera system and Bose sound system. Map coverage not available in Puerto Rico, the Virgin Islands and portions of Canada. <sup>11</sup> Requires available navigation radio or inside rearview mirror with rear camera display. <sup>12</sup> Requires available navigation radio.

<sup>1</sup> Always use safety belts and the correct child restraint for your child's age and size. Even in vehicles equipped with the Passenger Sensing System, children are safer when properly secured in a rear seat in the appropriate infant, child or booster seat. Never place a rear-facing infant restraint in the front seat of any vehicle equipped with an active air bag. See the Owner's Manual and child safety seat instructions for more safety information. <sup>2</sup> Call 1-888-4ONSTAR (1-888-466-7827), visit [onstar.com](http://onstar.com) and see the inside back cover of this catalog for details and system limitations. <sup>3</sup> The Bluetooth word mark is a registered trademark owned by Bluetooth SIG, Inc. and any use of such mark by Chevrolet is under license. Go to [gm.com/bluetooth](http://gm.com/bluetooth) to find out which Bluetooth phones are compatible with the vehicle. <sup>4</sup> XM is available only in the 48 contiguous United States. Required \$12.95 monthly subscription sold separately after three trial months. All fees and programming subject to change. Visit [gm.xradio.com](http://gm.xradio.com) for more details. <sup>5</sup> Not available in certain areas. Visit [onstar.com](http://onstar.com) for coverage maps. <sup>6</sup> Requires available tri-zone automatic climate controls and Universal Home Remote on 1LT. Not available with Snow Plow Prep Package. <sup>7</sup> Requires available Bose sound system in 1LT and 2LT. Requires available tri-zone automatic climate controls in 1LT. <sup>8</sup> Requires available rear-seat DVD entertainment system. <sup>9</sup> Use only GM-approved tire and wheel combinations. For important tire and wheel information, go to [gmaccessorieszone.com](http://gmaccessorieszone.com) or see your dealer for details. <sup>10</sup> Requires available power sunroof or rear-seat DVD entertainment system. Requires Bose sound system. <sup>11</sup> Requires available power sunroof and tri-zone automatic climate controls. Not available on 1LT or 2LT with Snow Plow Prep Package. <sup>12</sup> Requires available rearview camera system and Bose sound system. Map coverage not available in Puerto Rico, the Virgin Islands and portions of Canada. <sup>13</sup> Requires available navigation radio or inside rearview mirror with rear camera display. <sup>14</sup> Requires available navigation radio and Side Blind Zone Alert.

# SELECT TAHOE FEATURES. For a complete list, go to [chevy.com/tahoe/features](http://chevy.com/tahoe/features).

## TAHOE LS

- 17-inch aluminum wheels
- Vortec 4.8L V8 (2WD)
- Vortec 5.3L V8 with Active Fuel Management (4WD); includes six-speed automatic transmission
- Premium Cloth 40/20/40 split-folding front-row bench seat
- Premium Cloth 60/40 split-reclining second-row bench seat
- Third-row bench seat
- Head-curtain side-impact air bags<sup>1</sup>
- OnStar<sup>2</sup> with one-year Safe & Sound Plan
- StabiliTrak Electronic Stability Control System
- Bluetooth<sup>®</sup> wireless technology for select compatible phones<sup>3</sup>
- XM Radio<sup>4</sup> with three trial months

### Popular available features:

- Convenience Package: includes power-adjustable pedals, remote vehicle starter system, Ultrasonic Rear Parking Assist, rearview camera system and inside rearview mirror with rear camera display
- Automatic locking rear differential

## TAHOE 1LT

*In addition to or replacing LS features, 1LT includes:*

- Body-color door handles
- Foglamps
- Heated, body-color, power-adjustable outside mirrors
- Six-speed automatic transmission
- Premium Cloth front-row bucket seats with floor console
- OnStar<sup>2</sup> with one-year Directions & Connections Plan, including Turn-by-Turn Navigation<sup>5</sup>

### Popular available features:

- Convenience Package: see LS features for details
- Power sunroof<sup>6</sup>
- Rear-seat DVD entertainment system<sup>7</sup>
- 20-inch polished-aluminum wheels<sup>8</sup>
- Tri-zone automatic climate controls<sup>9</sup>
- Universal Home Remote<sup>10</sup>
- Touch-screen navigation radio<sup>11</sup>
- Bose<sup>®</sup> sound system
- Automatic locking rear differential

## TAHOE 2LT

*In addition to or replacing 1LT features, 2LT includes:*

- Ultrasonic Rear Parking Assist
- Custom Leather-appointed front-row bucket seats
- Custom Leather-appointed 60/40 split-folding second-row bench seat
- Tri-zone automatic climate controls
- Power-adjustable pedals
- Remote vehicle starter system
- Universal Home Remote
- Six-disc CD/MP3 changer and auxiliary audio input jack

### Popular available features:

- Z71 Off-Road Package, including automatic locking rear differential
- Touch-screen navigation radio<sup>11</sup>
- Bose<sup>®</sup> sound system
- 20-inch polished-aluminum wheels<sup>8</sup>
- Power sunroof
- Rear-seat DVD entertainment system<sup>7</sup>
- Side Blind Zone Alert
- 20-inch chrome-clad wheels<sup>8</sup>
- Vortec 6.2L V8 engine
- Rearview camera system<sup>12</sup>

## TAHOE LTZ

*In addition to or replacing 2LT features, LTZ includes:*

- Power-remote liftgate
- Chrome-capped, power-folding, heated outside mirrors with ground illumination and more
- 20-inch polished-aluminum wheels<sup>8</sup>
- Heated washer fluid system
- Rainsense front wipers
- Autoride suspension
- Heated and cooled perforated leather-appointed front-row bucket seats with 12-way power
- Heated second-row seats with power-release functionality
- Bose<sup>®</sup> Centerpoint<sup>®</sup> Surround Sound system

### Popular available features:

- Power sunroof
- Touch-screen navigation radio<sup>11</sup>
- Rear-seat DVD entertainment system<sup>7</sup>
- Power-articulating side steps<sup>13</sup>
- Side Blind Zone Alert
- 20-inch chrome-clad wheels<sup>8</sup>
- Vortec 6.2L V8 engine
- Rearview camera system<sup>14</sup>

## TAHOE HYBRID

*(at participating dealers only)*

- 18-inch aluminum wheels
- Lightweight liftgate with fixed glass
- Vortec 6.0L V8 with Active Fuel Management
- Two-mode Hybrid Propulsion Electric System and electronic ratio select transmission
- 115-volt/150-watt power inverter
- Heated, Custom Leather-appointed front-row bucket seats
- Custom Leather-appointed 60/40 split-folding second-row bench seat
- 50/50 split-folding three-passenger third-row bench seat
- Four-wheel antilock disc brakes with regenerative capability
- OnStar<sup>2</sup> with one-year Directions & Connections Plan, including Turn-by-Turn Navigation<sup>5</sup>
- Bluetooth<sup>®</sup> wireless technology for select compatible phones<sup>3</sup>
- Touch-screen navigation radio<sup>15</sup> and rearview camera system
- XM NavTraffic<sup>16</sup> with three trial years of service

### Popular available features:

- Power sunroof
- Rear-seat DVD entertainment system<sup>7</sup>

## TAHOE DIMENSIONS

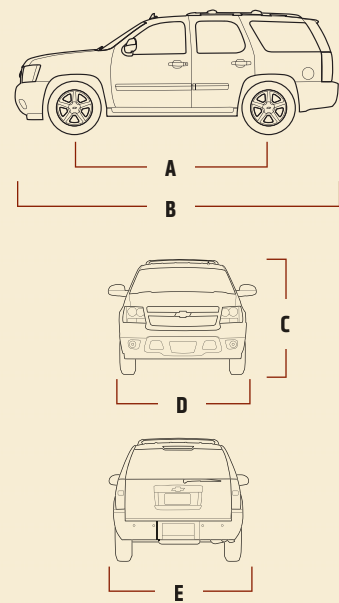

- A = 116.0"**
- B = 202.0"**
- C = 74.3" to 76.9" (2WD)**
- 74.3" to 76.9" (4x4)**
- D = 68.2"**
- E = 67.0"**

# IMPORTANT INFORMATION

**THE BEST COVERAGE IN AMERICA.** Every 2009 Chevy passenger car, light-duty truck, SUV and crossover comes with a 100,000 mile/5-year (whichever comes first) transferable Powertrain Limited Warranty. Plus, you get 100,000 miles/5 years (whichever comes first) of 24/7 Roadside Assistance, Courtesy Transportation and much more. See dealer for details.

**NEW VEHICLE LIMITED WARRANTY.** GM vehicles registered in the U.S.A. are covered for 3 years/36,000 miles (whichever comes first). The complete vehicle is covered, including tires, towing to your nearest Chevrolet dealership and cosmetic corrosion resulting from defects. Repairs will be made to correct any vehicle defect, and most warranty repairs will be made at no charge. In addition, rust-through corrosion will be covered for 6 years/100,000 miles (whichever comes first). Powertrain components will be covered for 100,000 miles/5 years (whichever comes first). See dealer for details.

**TAHOE HYBRID WARRANTY.** In addition to the transferable Chevy 36,000-mile/3-year (whichever comes first) New Vehicle Limited Warranty and the 100,000-mile/5-year (whichever comes first) Powertrain Limited Warranty, GM will also warrant certain hybrid components on Tahoe Hybrid models for 100,000 miles/8 years (whichever comes first). No deductibles are associated with the Tahoe Hybrid warranty, which is transferable to any subsequent persons assuming ownership of the vehicle during the 100,000-mile/8-year warranty period. See your Chevy dealer for details.

**ENGINES.** Chevrolet products are equipped with engines produced by GM Powertrain or other suppliers to GM worldwide. The engines in Chevrolet products may also be used in other GM makes and models.

**ASSEMBLY.** Chevrolet vehicles and their components are assembled or produced by different operating units of General Motors, its subsidiaries or suppliers to GM worldwide. We sometimes find it necessary to produce Chevrolet vehicles with different or differently sourced components than originally scheduled. Since some options may be unavailable when your vehicle is assembled, we suggest you verify that your vehicle includes the equipment you ordered and that, if there were changes, they are acceptable to you.

**ONSTAR.** OnStar services require vehicle electrical system (including battery), wireless service and GPS satellite signals to be available and operating for features to function properly. OnStar acts as a link to existing emergency service providers. Subscription Service Agreement required. Call 1-888-4ONSTAR (1-888-466-7827) or visit [onstar.com](http://onstar.com) for OnStar's Terms and Conditions, Privacy Policy, and details and system limitations. Additional information can be found in the OnStar Owner's Guide.

# WE'VE GOT YOUR BACK

At Chevrolet, giving you a completely satisfying ownership experience is our top priority. That's why if you ever need assistance, feel free to contact us at these web sites or phone numbers.

**CHEVY.COM.** Offers shopping tools such as Build and Price, Find a Vehicle, Request Info, Email Sign-Up, Compare Vehicles, Financial Tools...and much more.

**24-HOUR ROADSIDE ASSISTANCE (1-800-CHEV-USA).** Chevrolet Roadside Assistance provides you with the following services for 100,000 miles or 5 years (whichever comes first): Emergency Towing (to closest Chevy dealer from a legal roadway), Lockout Service (keys locked inside vehicle), Flat Tire Changes (spare installed), Fuel Delivery (\$5 worth of fuel delivered on the road) and Jump Starts (at home or on the road). For specific terms and conditions, please contact your Chevrolet Roadside Assistance advisor at 1-800-243-8872. Some services may incur costs.

**COURTESY TRANSPORTATION.** Ask your Chevrolet dealer for Courtesy Transportation if you leave your vehicle for extended repairs under the New Vehicle Limited Warranty or Powertrain Limited Warranty. Ask if you qualify for expense reimbursement and/or vehicle rental. Services vary by dealer.

**CHEVROLET CUSTOMER ASSISTANCE CENTER (1-800-222-1020).** Talk directly to customer relationship managers who can handle any inquiries related to vehicle operation, warranty coverages, or product or service concerns you may have. Please refer to your Owner's Manual for Customer Assistance information.

**CHEVY.COM/SAFETY.** Chevrolet is committed to keeping you and your family safe — from the start of your journey to your destination. That's why every Chevrolet is designed with a comprehensive list of safety and security features to help give you peace of mind.

**A NOTE ABOUT CHILD SAFETY.** Always use safety belts and the correct child restraint for your child's age and size. Even in vehicles equipped with the Passenger Sensing System, children are safer when properly secured in a rear seat in the appropriate infant, child or booster seat. Never place a rear-facing infant restraint in the front seat of any vehicle equipped with an active frontal air bag. Air bag inflation can cause severe injury or death to anyone too close to the bag when it deploys. Be sure every occupant is properly restrained. See the Owner's Manual and child safety seat instructions for more safety information.

**IMPORTANT WORDS ABOUT THIS CATALOG.** We have tried to make this catalog comprehensive and factual. We reserve the right, however, to make changes at any time, without notice, in prices, colors, materials, equipment, specifications, models and availability. Specifications, dimensions, measurements, ratings and other numbers in this catalog and other printed materials provided at the dealership or affixed to vehicles are approximates based upon design and engineering drawings, prototypes and laboratory tests. Your vehicle may differ due to variations in manufacture and equipment. Since some information may have been updated since the time of printing, please check with your Chevrolet dealer for complete details. Chevrolet reserves the right to lengthen or shorten the model year for any reason or to start and end model years at different times. Certain vehicle features may lose their usefulness over time due to obsolescence from technological changes. Unless otherwise noted, all claims based on 2008 GM segmentation and latest available competitive information. Excludes other GM vehicles.

**TRAILERING AND OFF-ROAD DRIVING INFORMATION.** Please go to [chevy.com](http://chevy.com) and carefully review an Owner's Manual for important safety information about trailering or off-road driving in your vehicle.

**SPARE TIRE INFORMATION.** There is no jack or spare tire and no place to store a tire in the 2009 Chevrolet Tahoe Hybrid. Your vehicle has a tire sealant and compressor kit that uses a liquid tire sealant to temporarily seal up to a one-quarter-inch puncture in the tread area of the tire. After using the tire inflator kit, it is recommended that you take the tire to an authorized retailer for inspection and repair as soon as possible, but at least within 100 miles of driving. The tire sealant cannot seal and inflate sidewall damage, punctures larger than one-quarter inch, or a tire that has unseated from the wheel. The sealant can only be used on one tire and for one time before its expiration date.

**GMMOBILITY.COM (1-800-323-9935).** GM Mobility offers financial assistance for eligible adaptive equipment to make automotive travel easier for persons with disabilities or special transportation needs. To learn more about special GM Mobility offers, visit [gmmobility.com](http://gmmobility.com).

**CHEVROLET OWNER CENTER (CHEVY.COM/MYGLINK).** Register your vehicle with the Chevrolet Owner Center, and receive benefits such as online access to your vehicle Owner's Manual, maintenance schedule reminders, service history tracking, warranty and service information, safety information, special offers and privileges, and news and events.

**MARKETING AND INCENTIVES (CHEVY.COM/SPECIALOFFERS).** Call 1-800-950-CHEV (1-800-950-2438) or visit [chevy.com/specialoffers](http://chevy.com/specialoffers) for new product, current incentive and marketing program information.

**GMCARDMEMBERSERVICES.COM.** Did you know about the family of reward credit cards that can help you get a great deal on a new GM car, light-duty truck, SUV or crossover? With a GM reward card, you accrue earnings on every credit card purchase to use toward the purchase or lease of an eligible, new GM vehicle. With three cards to choose from, you're sure to find one that suits you best.

GM, the GM Logo, Chevrolet, the Chevrolet Logo, and the slogans, emblems, vehicle model names, vehicle body designs and other marks appearing in this catalog are the trademarks and/or service marks of General Motors Corporation, its subsidiaries, affiliates or licensors. Bose, CenterPoint and SurroundStage are registered trademarks of the Bose Corp. OnStar, Safe & Sound and Directions & Connections are registered service marks of OnStar Corp. The Bluetooth word mark is a registered trademark owned by Bluetooth SIG, Inc. and any use of such mark by Chevrolet is under license. Go to [gm.com/bluetooth](http://gm.com/bluetooth) to find out which Bluetooth phones are compatible with the vehicle. The XM and XM NavTraffic names are registered trademarks of XM Satellite Radio Inc. iPod is a mobile digital device. iPod is a registered trademark of Apple, Inc. All rights reserved. ©2008 General Motors Corporation. All rights reserved. Litho in U.S.A. July 2008

<sup>1</sup> Always use safety belts and the correct child restraint for your child's age and size. Even in vehicles equipped with the Passenger Sensing System, children are safer when properly secured in a rear seat in the appropriate infant, child or booster seat. Never place a rear-facing infant restraint in the front seat of any vehicle equipped with an active air bag. See the Owner's Manual and child safety seat instructions for more safety information. <sup>2</sup> Call 1-888-4ONSTAR (1-888-466-7827), visit [onstar.com](http://onstar.com) and see the inside back cover of this catalog for details and system limitations. <sup>3</sup> The Bluetooth word mark is a registered trademark owned by Bluetooth SIG, Inc. and any use of such mark by Chevrolet is under license. Go to [gm.com/bluetooth](http://gm.com/bluetooth) to find out which Bluetooth phones are compatible with the vehicle. <sup>4</sup> XM is available only in the 48 contiguous United States. Required \$12.95 monthly subscription sold separately after three trial months. All fees and programming subject to change. Visit [gm.xmradio.com](http://gm.xmradio.com) for more details. <sup>5</sup> Not available in certain areas. Visit [onstar.com](http://onstar.com) for coverage maps. <sup>6</sup> Requires available tri-zone automatic climate controls and Universal Home Remote. <sup>7</sup> Requires available Bose sound system in 1LT and 2LT. Requires available tri-zone automatic climate controls in 1LT. <sup>8</sup> Use only GM-approved tire and wheel combinations. For important tire and wheel information, go to [gmaccessorieszone.com](http://gmaccessorieszone.com) or see your dealer for details. <sup>9</sup> Requires available power sunroof or rear-seat DVD entertainment system. Requires Bose sound system. <sup>10</sup> Requires available power sunroof. <sup>11</sup> Requires available rearview camera system. Map coverage not available in Puerto Rico, the Virgin Islands and portions of Canada. <sup>12</sup> Requires available navigation radio or inside rearview mirror with rear camera display. <sup>13</sup> Requires available navigation radio and Side Blind Zone Alert. <sup>14</sup> Requires available navigation radio. <sup>15</sup> Map coverage not available in Puerto Rico, the Virgin Islands and portions of Canada. <sup>16</sup> Required XM Radio and XM NavTraffic monthly subscriptions sold separately after trial period. XM NavTraffic only available in select markets. All fees and programming subject to change. Subscriptions subject to customer agreement available at [gm.xmradio.com](http://gm.xmradio.com). XM service only available in the 48 contiguous United States.

