

# 1969 CORVETTE

Putting you first, keeps us first 

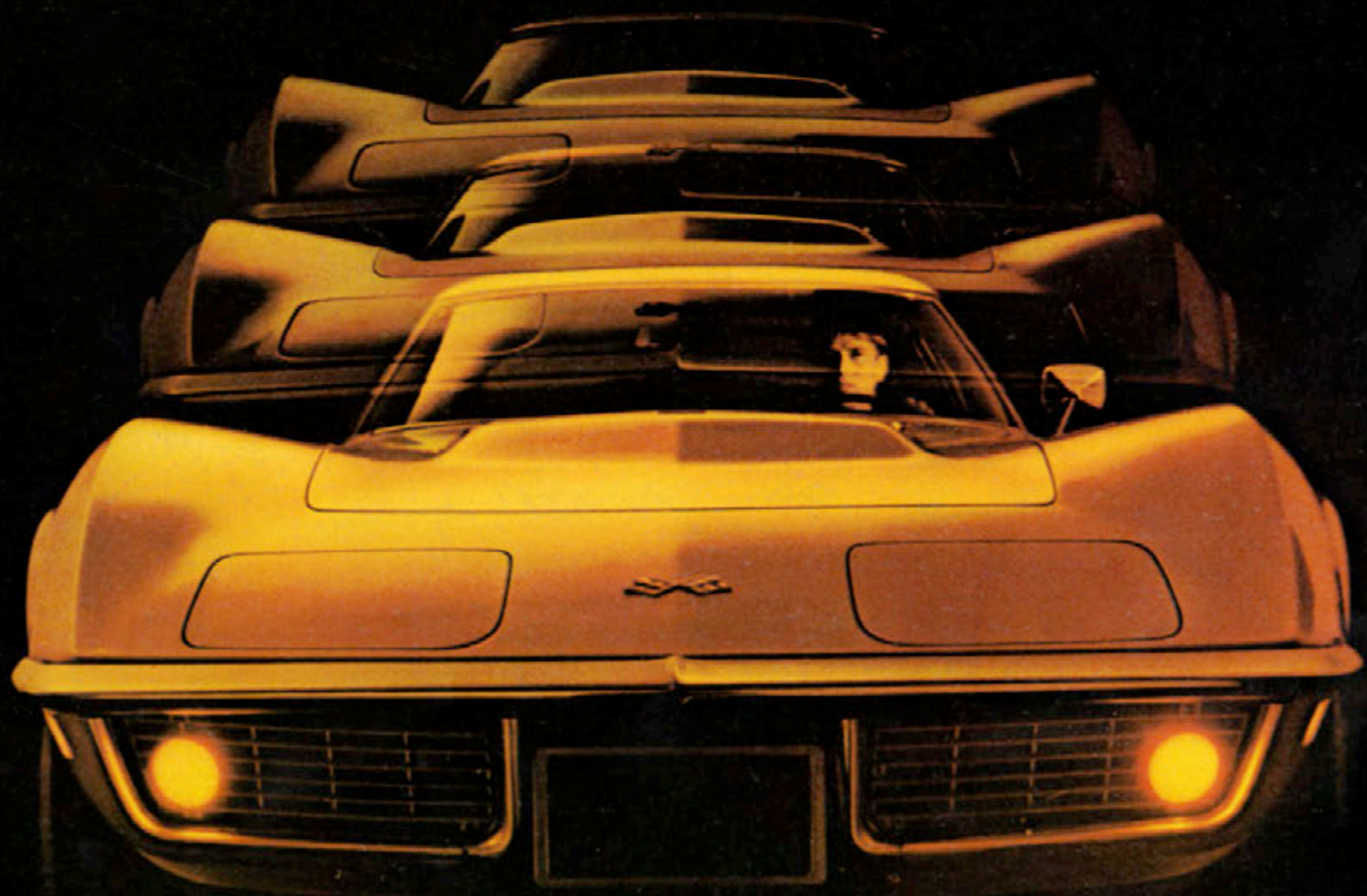



No need to beware of substitutes. There aren't any.





## There's no mistaking a Corvette for anything but a Corvette.

The aerodynamic lines of America's original sports car make it the one automobile nobody mistakes for anything else. In Coupe or Convertible this is the genuine article,

designed and engineered without compromise. Corvette stands proudly alone, because nobody but Chevrolet can turn out a car like this on a production line.

And it's as honest as it is beautiful. As you've learned to expect, Corvette goes, stops and handles like nothing else. The basic engine this year is a very healthy 350 CID 300-hp

V8 (plenty enough for most, but if you like, you can order one with up to 435-hp). Of course, Corvette is still the stopper, too, with disc brakes at all four wheels. Road-

grabbing 15-inch wide ovals plus new 8-inch wide wheels and wider tread give Stingray a better grip . . . and an even bolder appearance. Other subtle but significant refine-

ments include a stronger, more rigid frame for improved ride and handling, new maximum security 3-way locking system on the steering column and unique headlight

washers that even clean in motion with jets of water.

Shown here are the ways you can get it: Coupe with removable hardtop sections; Convertible with soft top or

removable hardtop. For a more complete list of Corvette extra-cost Options and Custom Features illustrated or described throughout this book, see Page 11.

Corvette Stingray Coupe.

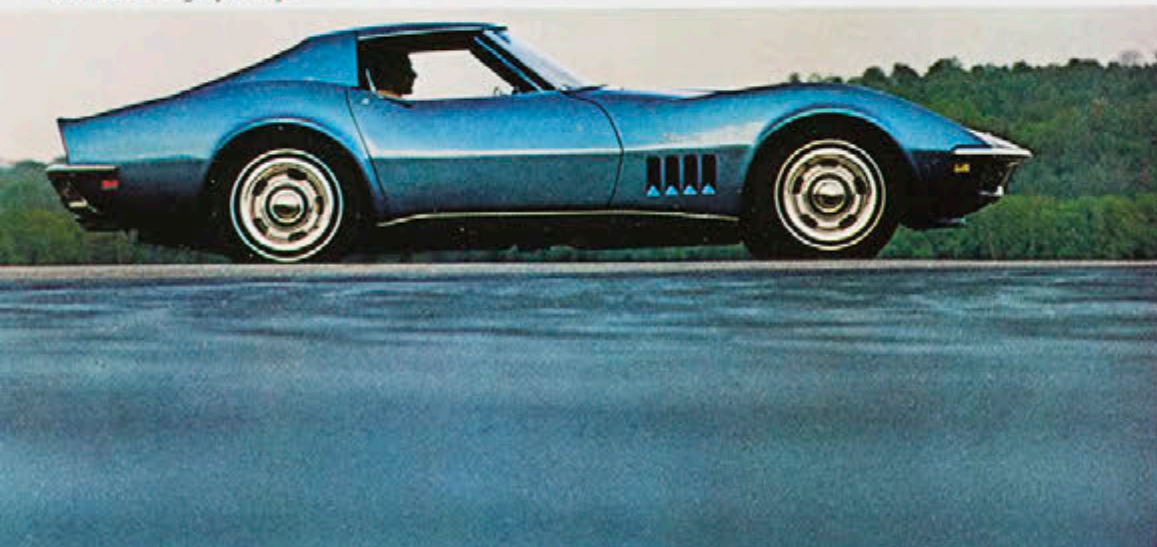

Coupe with roof sections removed.



Convertible with top down.



Vinyl-covered removable hardtop.

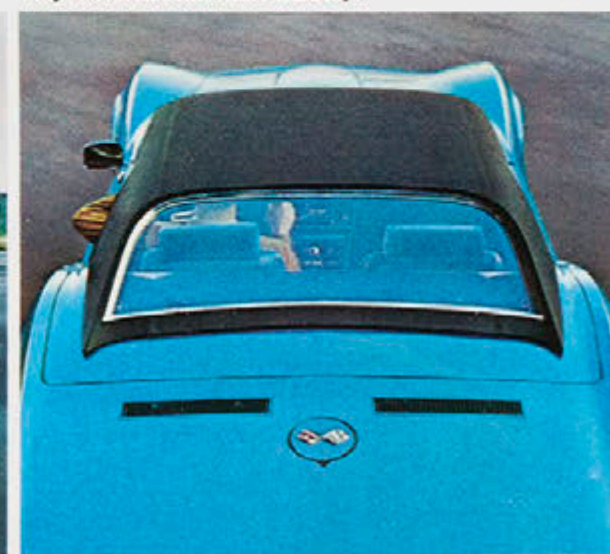

Headlight washers.

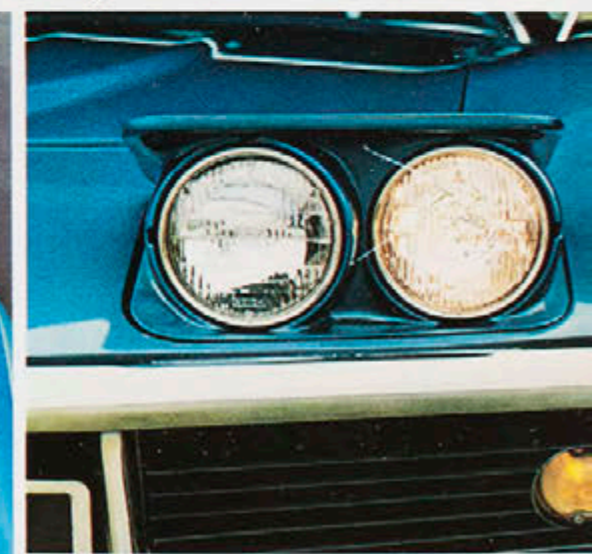

Corvette Stingray with removable hardtop in place.



## If it has anything to do with the engine, there's a gauge for it.

The man that drives this kind of car likes to know what's happening... so Corvette has a gauge for everything but your blood pressure. Tachometer, ammeter, oil pressure, sweep second rally clock, fuel gauge,

mileage and trip odometer, warning lights for seat belts, headlight position and door ajar. The center console houses fingertip controls for the heater, defroster, radio, vents, ashtray, cigarette

lighter, shift lever and parking brake, plus an engine rating plate and softly glowing space-age fiber optics that monitor outside running lights. Color-keyed deluxe pushbutton seat belts and

inertia action shoulder belts, on the Coupe, retract out of the way when not in use.

Now settle down into that remarkably comfortable contoured slimline bucket seat and enjoy the just right feel of

the new competition steering wheel with the resilient rim. Notice that the windshield wipers and their new integral washers are completely hidden from view when not in use. After you get roll-

ing, improved Astro Ventilation provides noiseless, draft-free outside air. Color keyed comfort extends to the use of deep, soft carpeting that stretches back across the luggage area. Under that

carpeting behind the seats you'll find stowage areas housing the battery, another for the jack and tools and a third for valuables (with a pushbutton key lock). More inside news includes door

assist grips, armrests designed to shield door handles and lock buttons, rear compartment courtesy light and built-in head restraints. Nice touches. That's how it's been for 17 years of refining one great idea.

Corvette Stingray Coupe with Turbo Hydra-Matic Transmission you can order.

Center, top to bottom: Standard fully synchronized 3-Speed Transmission. 4-Speed Transmission is available. A center console is standard.

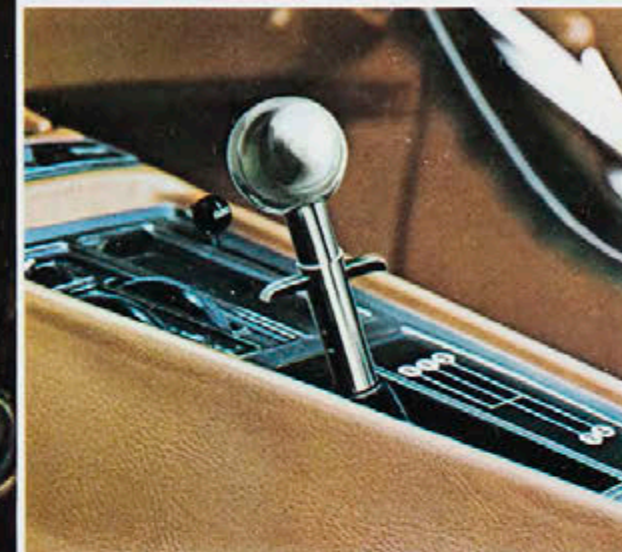



## 300-hp, 350-hp, 390-hp, 400-hp, 435-hp. Say when.

To propel your Stingray you can choose this 427 CID powerplant with a special high domed hood—or any one of its spirited brothers.

The choice you make depends primarily on what kind of spirited performance suits you best. Check the specifications and pick the trans-

mission and rear axle ratio that fit your idea of sports car capability and you'll have a tailor-made package.

How about triple 2-barrel

carburetion? You get it with the 435-hp and the 400-hp 427 CID engines. Want Turbo Hydra-Matic? It's available with all three Turbo-Jet 427

435-hp Turbo-Jet 427 V8.

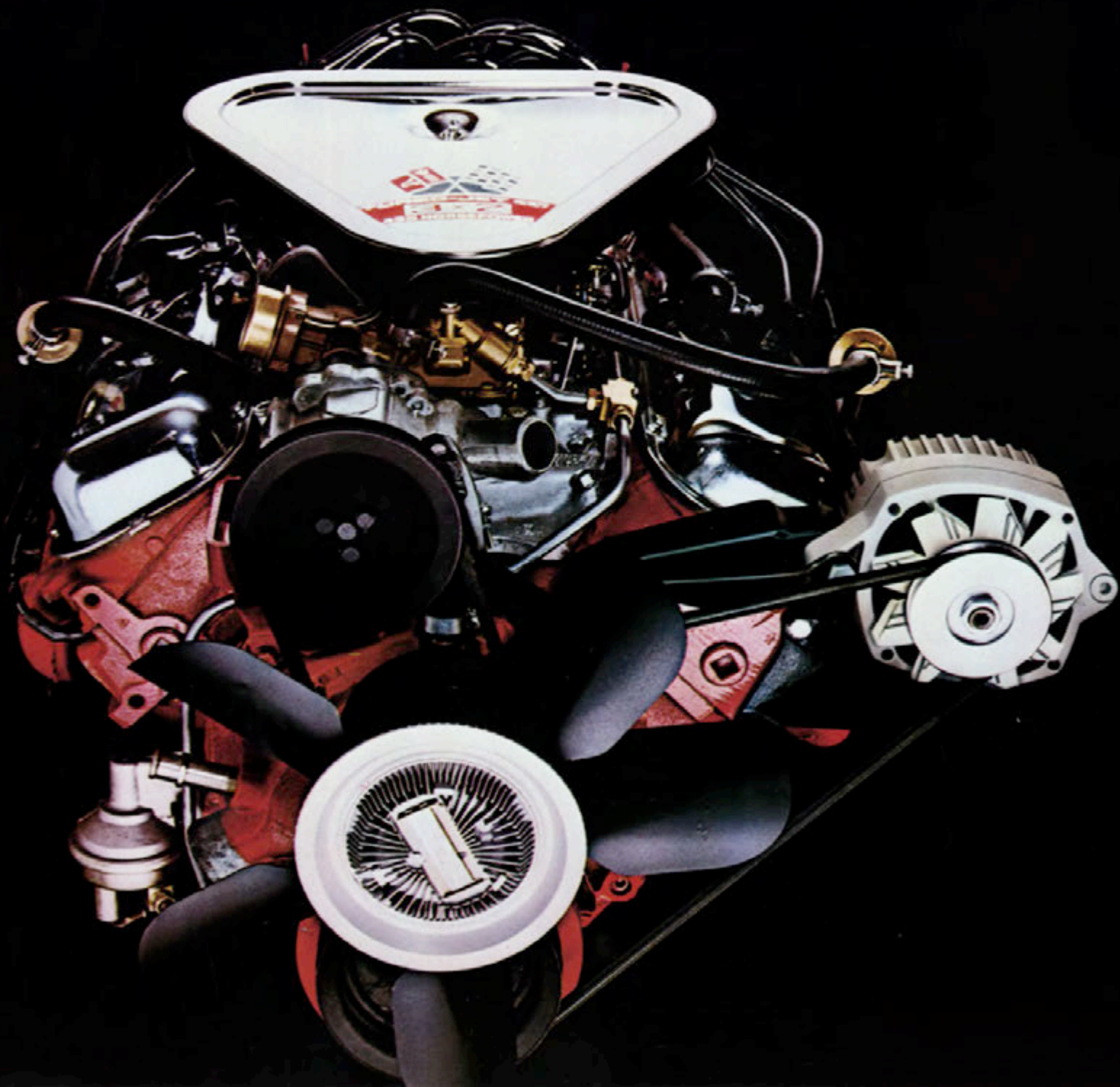



V8's in addition to the standard 300-hp V8. Prefer 4-Speed? You have a choice of gear ratios offered with all engines except the standard 300-hp and the 435-hp V8.

New Corvette power team features for '69 include new, larger 350 CID 300-hp engine as standard, or a 350-hp version is available, sturdier engine construction on the 350 CID, thicker bulkheads and main bearing caps, firmer crankshaft clamping with longer washer head bolts, extra-firm 4-bolt main bearing cap attachment and improved cooling system.

We even have a special engine (L-88) that we don't recommend for street use.

**Transmissions:** Standard 3-Speed fully synchronized; 4-Speed fully synchronized (wide-range or close-ratio); Turbo Hydra-Matic which operates automatically unless you want to shift it—through three forward ranges.

Of course, four-wheel disc brakes are still standard on Corvette—and in stopping ability, fade resistance and modulation they're very much appreciated by just about anybody interested in sports cars. Other features you get with Corvette include a new anti-interference ignition system, a high-output Delcotron generator, high-capacity energizer type battery—rustproof fiber glass body—and everything put together with a thoroughness and attention to detail that Corvette owners fully understand.

Standard equipment safety and security features on the 1969 Corvette include: energy-

absorbing steering column

seat belts with pushbutton buckles  shoulder belts with inertia retractors (Coupe only)  head restraints

passenger-guard door locks  safety door latches and hinges  four-way hazard warning flasher

dual master cylinder brake system with warning light and corrosion-resistant brake lines  tire safety rims

folding seat back latches  dual-speed windshield wipers and washer  dual-action safety hood latch

outside rearview mirror  back-up lights  side marker lights and parking lights that illuminate with headlights  energy-absorbing instrument panel

padded sun visors  reduced-glare instrument panel top, inside windshield mouldings, steering wheel hub and windshield wiper arms and blades

wide inside day-night mirror with deflecting base  lane-change feature in direction signal control  safety armrests

thick-laminate windshield  soft, low-profile window control knobs

smooth contoured door and window regulator handles  anti-theft ignition key warning buzzer  starter safety switch (to prevent engine starting when in gear) on all transmissions

snag-resistant steering wheel hardware  non-projecting wheel trim  improved fuel tank retention  headlight aiming access provision

fail-safe concealed headlights  anti-theft ignition, steering and transmission lock.

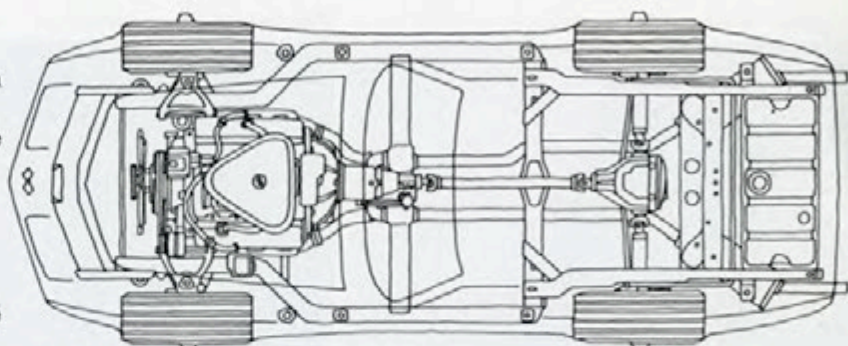

Top view of chassis.

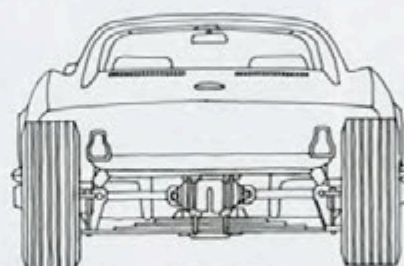

Fully independent rear suspension.

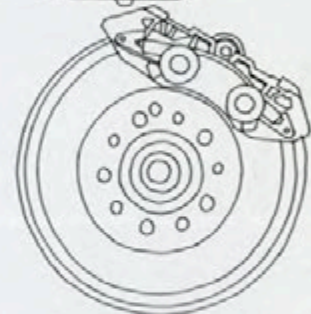

Advanced design disc brakes.

Engine	Transmission	Rear Axle Ratio (:1)							
		Without Air Cond.				With Air Cond.			
		Std	Econ	Perf	Spcl	Std	Econ	Perf	Spcl
<b>BASE ENGINE</b>									
300 HP Turbo-Fire 350 350-Cu.-In. V8	3-Speed (2.54:1 Low)	3.36	3.08			3.36	3.08		
	4-Speed (2.52:1 Low)	*	**			*	**		
	Turbo Hydra-Matic	3.08				3.08			
<b>OPTIONAL ENGINES</b>									
350 HP Turbo-Fire 350 350-Cu.-In. V8 RPO L46	4-Speed (2.52:1 Low)	3.36		3.55		3.36		3.55	
	4-Speed (2.20:1 Low)	3.70		4.11		3.70		4.11	
	4-Speed (2.52:1 Low)	3.08		3.36		3.08			
390 HP Turbo-Jet 427 427-Cu.-In. V8 RPO L36	4-Speed (2.20:1 Low)	3.36	3.08	3.55	3.70	Air Conditioning Not Available			
	Turbo Hydra-Matic	3.08	2.73			3.08	2.73		
	4-Speed (2.52:1 Low)	3.08		3.36		3.08			
400 HP Turbo-Jet 427 427-Cu.-In. V8 RPO L68	4-Speed (2.20:1 Low)	3.36	3.08	3.55	3.70	Air Conditioning Not Available			
	Turbo Hydra-Matic	3.08	2.73			3.08	2.73		
	4-Speed (2.20:1 Low)	3.55	3.36	3.70	4.11	Air Conditioning Not Available			
435 HP Turbo-Jet 427 427-Cu.-In. V8 RPO L71	Turbo Hydra-Matic	3.08	2.73	3.36					
	4-Speed (2.20:1 Low)	3.55	3.36	3.70	4.11	Air Conditioning Not Available			
<b>SPECIAL HIGH PERFORMANCE ENGINE (OFF-ROAD APPLICATION ONLY)</b>									
430 HP Turbo-Jet 427 427-Cu.-In. V8 RPO L88	H.D. 4-Speed (2.20:1 Low)	3.36	3.08	3.55	3.70	Air Conditioning Not Available			
	Turbo Hydra-Matic	3.08	2.73	3.36	4.56	Air Conditioning Not Available			

\*Positraction available. \*\*Positraction required.



## Why shouldn't you have air conditioning if you want it?

No good reason. It's just a useless old idea about sports cars being generally uncomfortable. Corvette buried all that nonsense with a lot of modern ideas that make driving more fun and a whole lot more comfortable.

Air-conditioned comfort is

just the beginning. A steering wheel that telescopes and tilts up and down adds another large degree of pleasure to any driving situation. For winter weather add a rear window defroster for Convertible or Coupe.

Handsome bits of dash

include wheel covers and bright trim for the front fender louvers. There are six new colors for '69, total of ten: Tuxedo Black  Can-Am White  Monza Red  LeMans Blue  Fathom Green  Daytona Yellow  Cortez Silver

Monaco Orange  Burgundy  Riverside Gold. Order interior trim in coordinated standard all-vinyl or extra-cost genuine leather in: Black  Saddle  Red  Bright Blue  Gunmetal  Green. Convertible top colors are

black or white. A black vinyl roof cover for the removable hardtop can be ordered.

Other extras for your consideration: Aluminum cylinder heads for the 435-hp engine  Compass  Deck lid luggage carrier  Emergency road kit  Clear vinyl floor

mats  Full-transistor ignition system (not available with 300-hp Turbo-Fire 350 V8)  Gas cap lock  Hand portable spotlight  Side-mounted exhaust system  Positraction rear axle  Power brakes  Power steering  Heavy-

duty dual disc clutch  Special brake system  Engine block heater  Power windows  Push-button AM/FM radio with twin speakers  FM Stereo multiplex  Rear window defroster  Removable hardtop for Convertible

(may be specified as standard in lieu of folding convertible top)  Special purpose front and rear suspension with 435-hp engine  Speed warning indicator  Tilt-telescopic steering wheel  Audio alarm system  Red or white stripe tires.

Deluxe wheel covers.

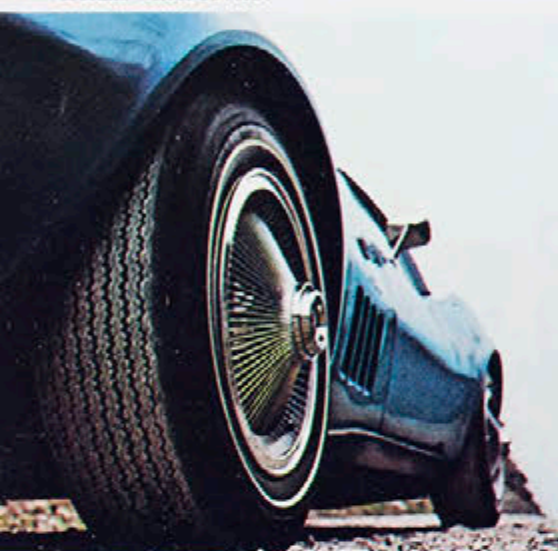

Four-Season air conditioning.

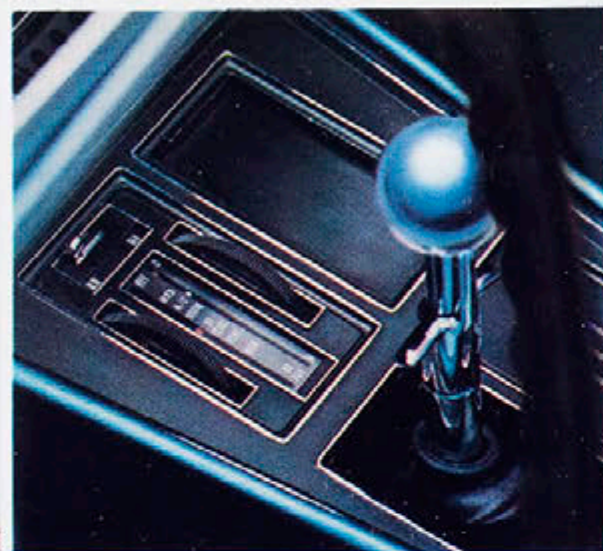

Positraction.



Luggage rack.

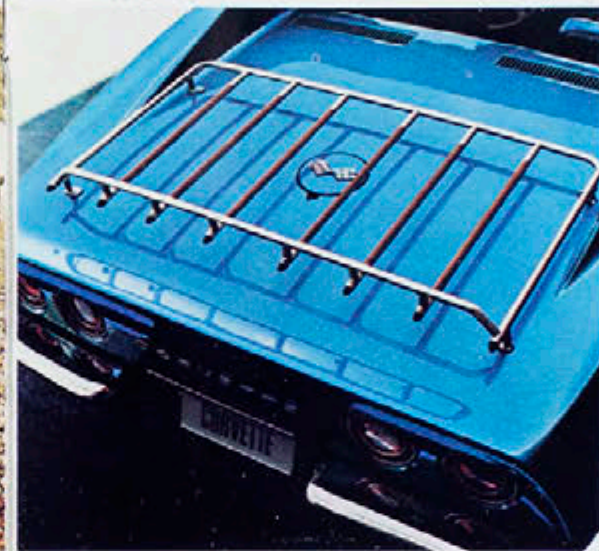

Off-road exhaust system.



Front fender louver trim.

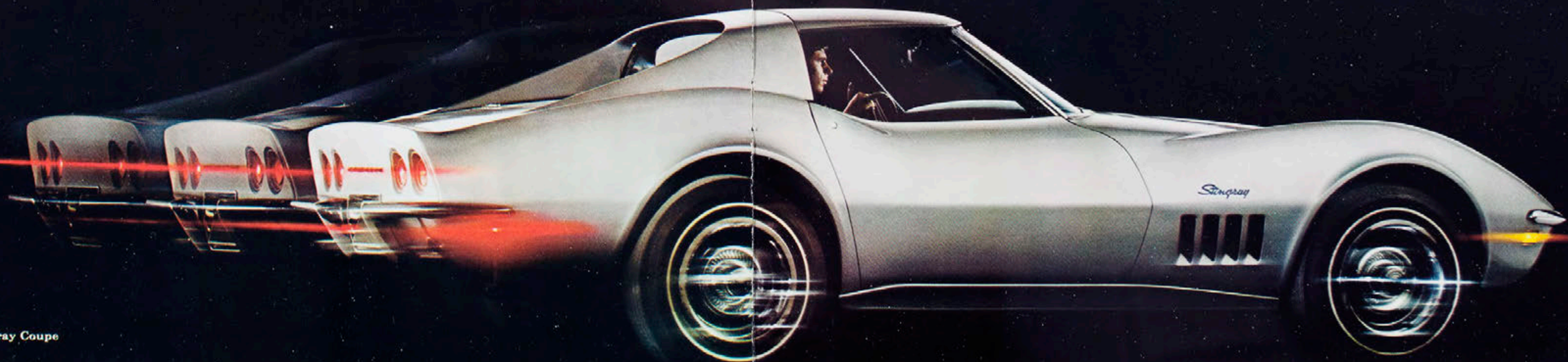

Corvette Stingray Coupe



All illustrations and specifications in this literature are based on the latest product information available at the time of publication approval. The right is reserved to make changes at any time without notice in prices, colors, equipment, specifications and models, and also to discontinue models. Chevrolet Motor Division, General Motors Corporation, Detroit, Mich. 48202.

## Corvette Stingray Coupe

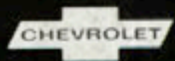
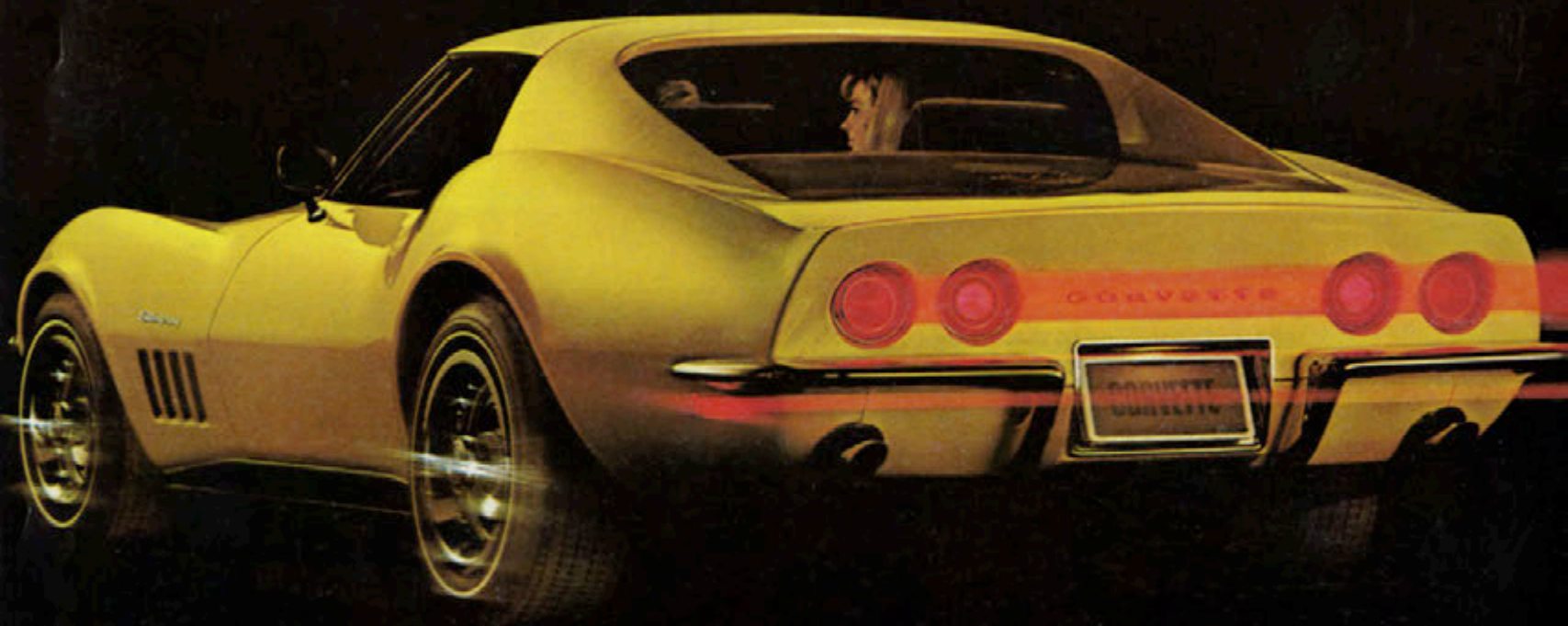

Litho in U.S.A.—D-67141

