

explorer
ninety-nine

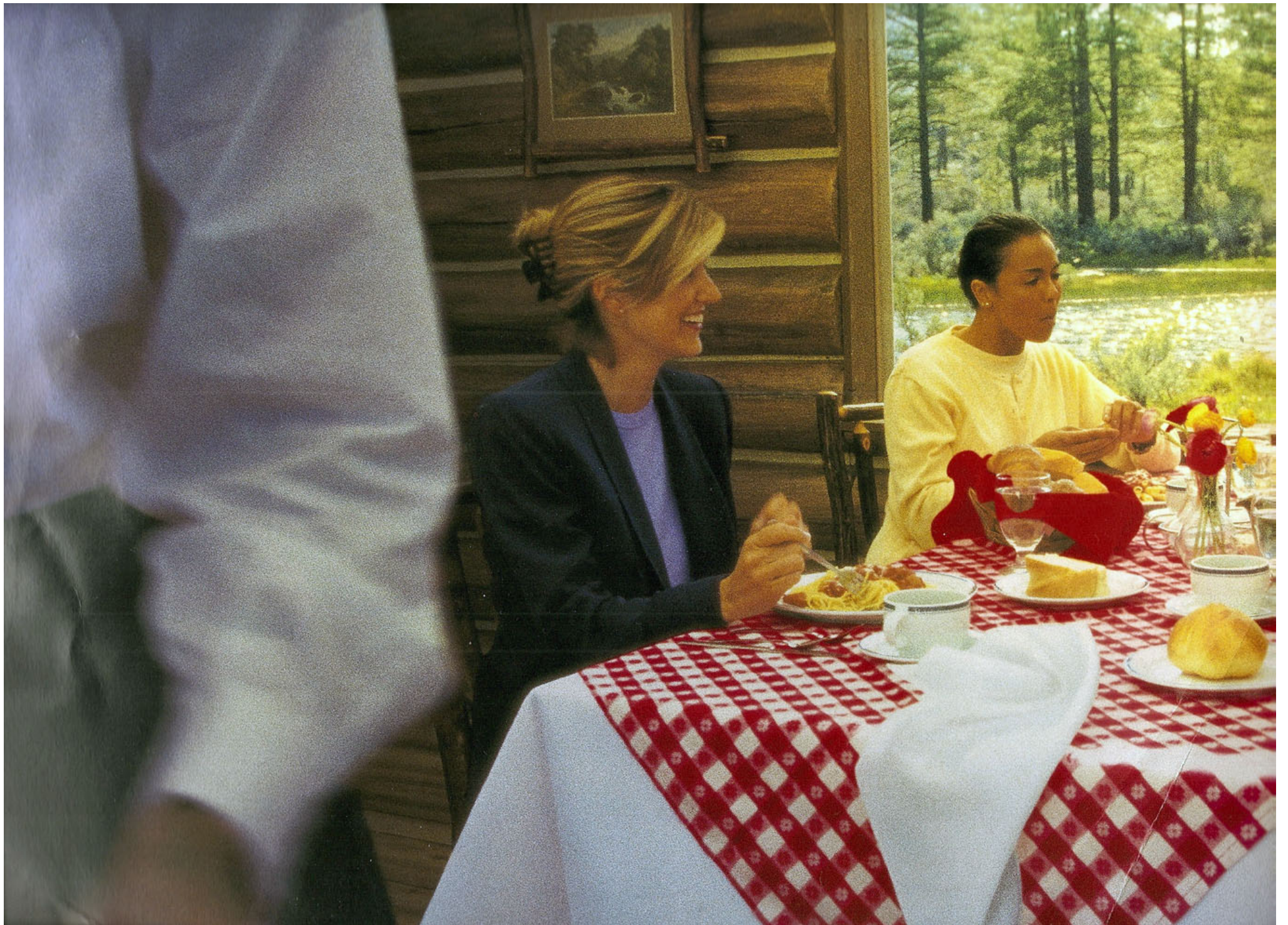





"All I'm saying is, when you're in an Explorer, going
downtown for Italian seems a little tame," objected

Tom. It looked as though the dining plans for the two
couples were about to change. "Okay," said Bill, "how

about we **take that dirt road
up to the lodge** and have dinner

at the restaurant there? And besides, the view's great."

The others nodded their approval, but Tom was still a
little curious, "What kind of restaurant is it, anyway?"

Bill cracked a faint smile and said, "Northern Italian."





Explorer Limited shown in Spruce Green Clearcoat Metallic.

Explorer Limited



Explorer Limited shown in Spruce Green Clearcoat Metallic.

The Explorer Limited provides **incomparable luxury** and style with features such as the rich woodgrain trim, color-keyed grille, surround moldings and front and rear bumpers which create a monotone appearance. The **heated front seats**, designed with premium leather trim and front power lumbar support, are available on the Limited. **Technological advances** such as the MACH[®] Audio System, heated mirrors with puddle lamps, and electronic automatic temperature control also add to the comfort and luxury of the Limited.



Electrochromic rearview mirror detects high/low beams and adjusts automatically for excellent visibility.

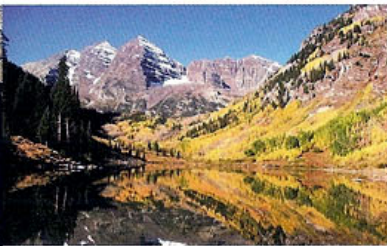

Exclusive to the Limited is the rich woodgrain trim interior which adds a sophisticated touch.

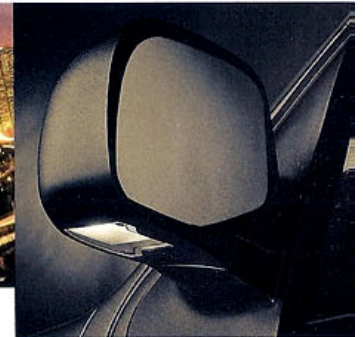
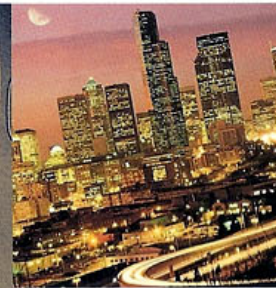

Heated mirrors with puddle lamps help clear ice and snow and provide excellent visibility.



Explorer Eddie Bauer shown in Medium Wedgewood Blue Clearcoat Metallic.

Explorer Eddie Bauer



Explorer Eddie Bauer shown in Medium Wedgewood Blue Clearcoat Metallic.

The Explorer Eddie Bauer offers all the **freedom and adventure** that you've come to expect from Ford and Eddie Bauer.

And just like its namesake, the Explorer Eddie Bauer is at home in the country or in the city with its **rugged durability and sleek styling**. And, this year, Ford is proud to announce that all Explorers will be classified as **Low Emissions Vehicles (LEVs)**, emitting 40% lower smog forming emissions than before. In fact Explorer is cleaner than most passenger cars on the road today, because taking care of **OUR environment** is important to everyone.



to premium console, equipped with message center, monitors 30 vehicle activities, including minders for your next oil change.



MACH® Audio System with Premium AM/FM stereo/cassette/single CD can be easily accessed by auxiliary controls located on the steering wheel.

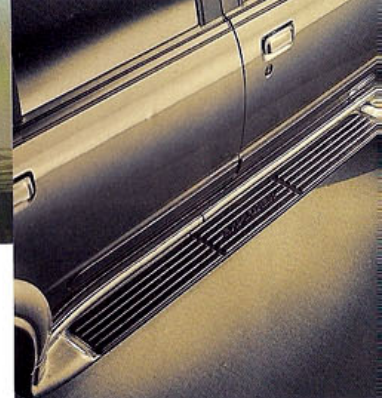

Standard illuminated running boards help provide excellent visibility and easy access to vehicle.



Explorer XLT shown in Black Clearcoat

Explorer XLT



Explorer XLT shown in the available two-tone Toreador Red and Platinum Clearcoat Metallic.

The Explorer XLT offers function, **practicality and value** without sacrificing any of the quality and comfort you've come to expect from the Explorer nameplate. **Standard features** include remote keyless entry, cloth sport bucket seats with six-way power driver's seat, leather-wrapped steering wheel and the SecuriLock™ passive anti-theft system. Other features, such as the 60/40 split/fold rear seat, allow you to **carry cargo or passengers with ease** according to your needs.

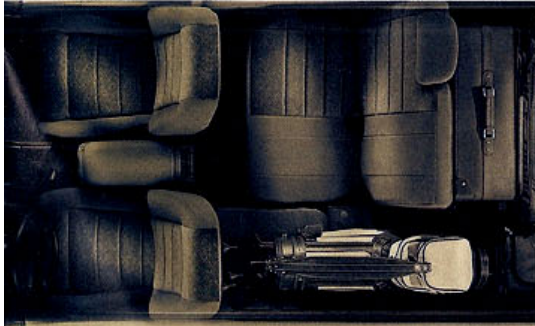

60/40 split/fold rear seat provides versatility in transporting cargo and passengers.



Interior cloth sport bucket seats offer stylish comfort.



Liftgate with flip glass allows you the convenience of opening the liftgate or simply the glass.



Explorer XLS shown in Harvest Gold Clearcoat Metallic

Explorer XLS



Explorer XLS shown in Harvest Gold Clearcoat Metallic.

The four-door XLS is an all-new model for 1999. Its design offers unique styling with comfort and convenience, while its many standard features, including 4-wheel ABS, luggage rack, power windows, power door locks and electric mirrors, make it an exceptional value. The Explorer XLS combines comfort with sportiness, making it the perfect vehicle for on- and off-road adventure.



Center console with removable storage bag allows you to store and access needed items easily.



Side step bars add a sleek styling touch.



Chrome steel wheels are unique to the XLS and add to the sporty appearance.



Explorer Sport shown in Bright Red Clearcoat.

Explorer Sport



Explorer Sport shown with available Premium Sport Group in Black Clearcoat.

The Explorer 2-door Sport is what driving is all about, embodying the spirit of off-road adventure. Driving enthusiasts can enjoy its aggressive styling and sporty details such as the available 4.0L V6 SOHC engine with its 210 horsepower, Control-Trac system, cast aluminum wheels and all-terrain tires. The Explorer Sport can also be customized with a choice of up to three option groups, the Convenience, Comfort, or Premium Sport Group.



Available Premium AM/FM/stereo/cassette/single CD Premium Sound (80 watts) with the Personal Audio System allows front and rear seat passengers to listen to different types of media simultaneously with the rear seat audio controls.



Available fog lamps help improve visibility in bad weather conditions.



Available power moonroof with the one-touch-open feature can be tilted up or opened completely.

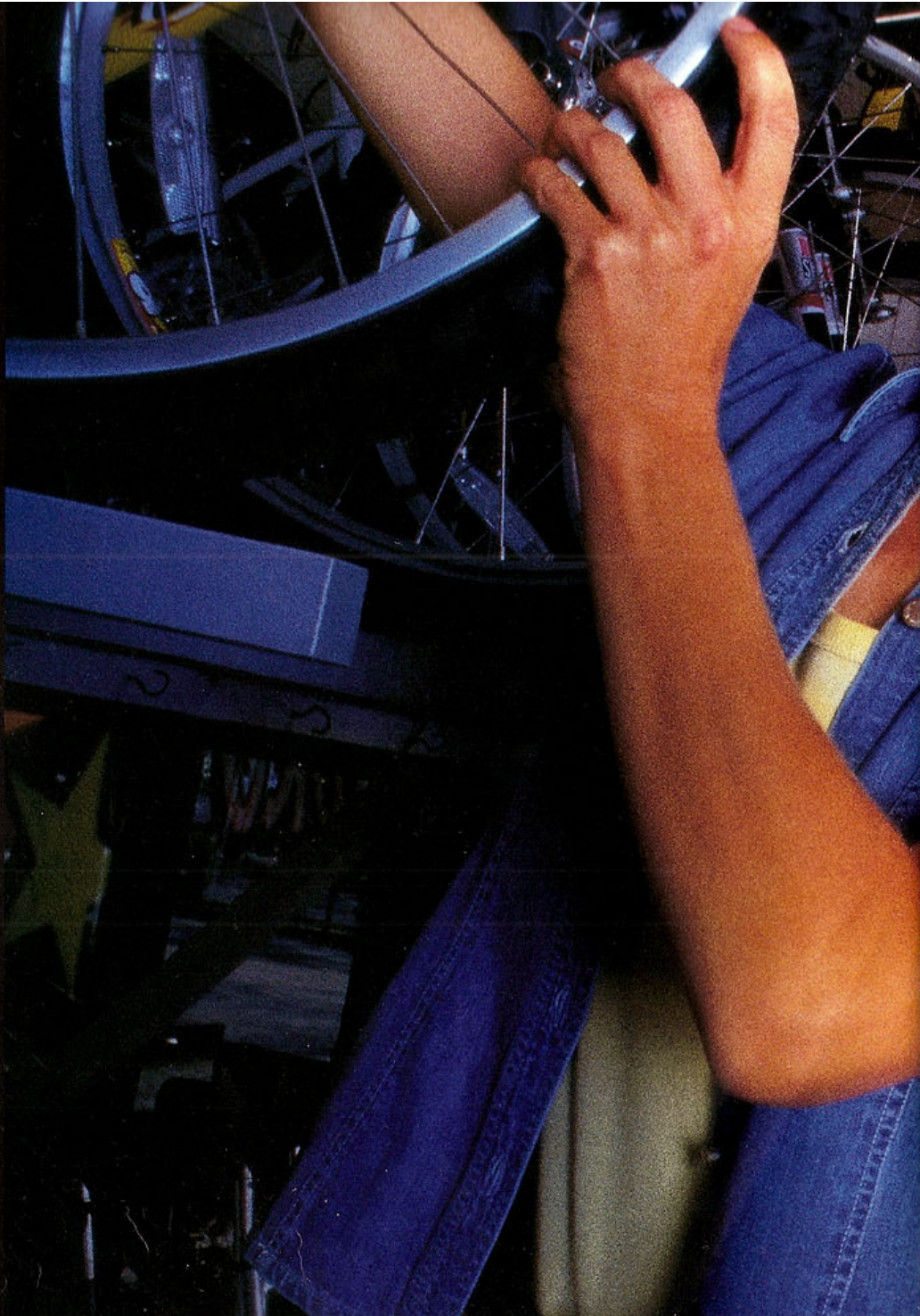

Denise and Sally love to go shopping. But there are no perfume counters or designer gowns for these ladies today. They're headed straight for the mountain bikes and that 24-speed beauty they've had their eyes on for weeks now. Of course it's **just gone on sale**, but that doesn't keep them from making the salesman give them a little better deal.



"We are buying two bikes, not one." Loading them on the Explorer Sport, they start laughing, because in their own words, all this shopping has made them "absolutely ravenous."



safety & convenience

The Explorer is the rare vehicle that is comfortable in the city or in the country. Its unique styling and many convenience options make it the perfect mode of transportation for those urban settings, while its powerful drivetrain helps make it ideal for even the most rugged terrain. Like all Ford vehicles, Explorer has been designed to protect its occupants and to provide years of dependable service to its owners. In fact there are more Explorers on the road today than any other sport utility vehicle.

– Source: R.L. Polk National Vehicle Population as of 7/1/97



safety and security

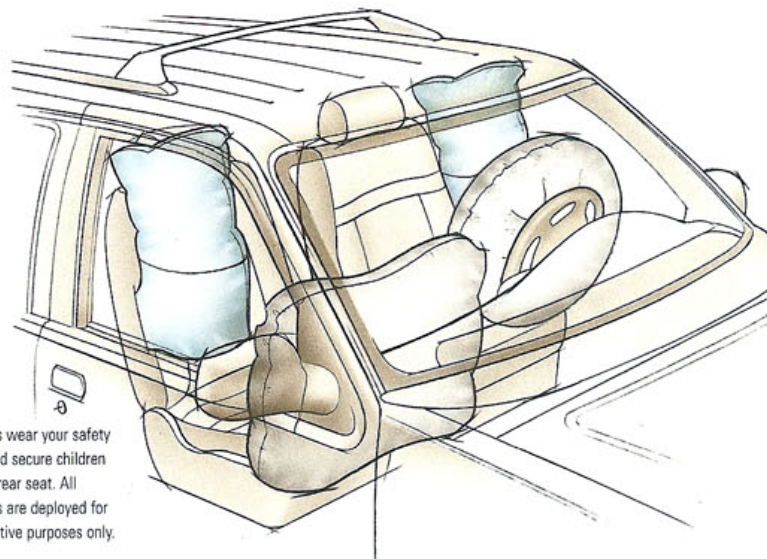

Always wear your safety belt and secure children in the rear seat. All airbags are deployed for illustrative purposes only.

The Explorer is Built Ford Tough with its solid side door intrusion beams and rigid construction which also provides added protection. New available front seat side airbags and standard Second Generation Depowered front airbags deploy with less force to further enhance occupant safety. Other safety and security features include the SecuriLock™ passive anti-theft system, Remote Keyless Entry system and 4-wheel anti-lock brakes.

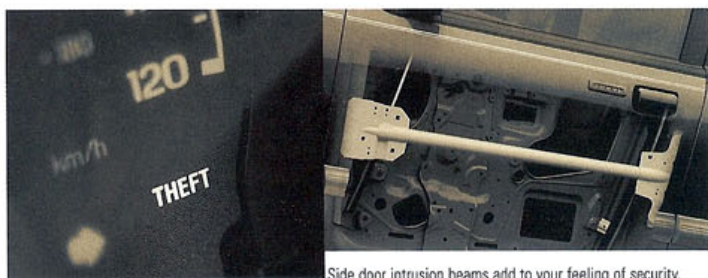

Side door intrusion beams add to your feeling of security.

SecuriLock™ is a passive anti-theft system which protects your vehicle electronically against theft and comes standard. Vehicle will not start without your specially coded key, and activation is indicated by a dash light.



Remote keyless entry allows you to lock or unlock your car via remote transmitter.

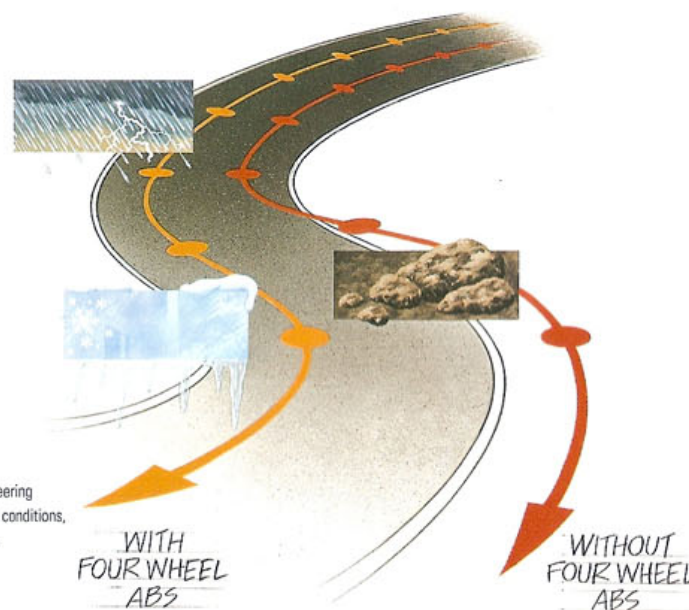

Four-wheel ABS helps provide steering control while braking under most conditions, even on wet or slippery surfaces.

WITH
FOUR WHEEL
ABS

WITHOUT
FOUR WHEEL
ABS

convenience



In adverse driving conditions Control-Trac will distribute torque to the wheels, adjusting for loss of traction.

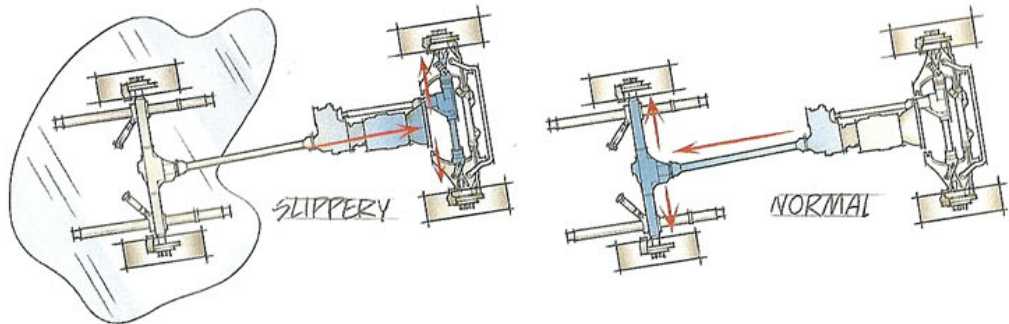

New Homelink System with Travelnote can operate up to three separate remotes, while the Travelnote feature allows you to record memos to yourself for future playback.

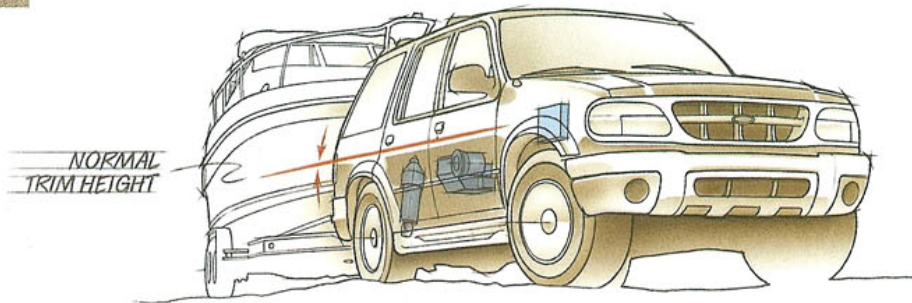

Available rear load-leveling suspension helps to improve ride, handling and trailer towing.

The Explorer provides the utmost in convenience

and comfort to its driver. Features include available 6-way power

driver/passenger seat, Reverse Sensing System and Control-Trac.

When wheel slippage occurs, **Control-Trac**, a driver-controlled

4x4 system, can automatically adjust the torque to give the wheels

better traction. A convenience feature new to the Explorer

this year is the **Reverse Sensing System**, perfect for

parallel parking.

Available new Reverse Sensing System alerts the driver to the presence of certain objects near the rear of the vehicle when backing up slowly during parking maneuvers. Ultrasonic sensors in the bumper detect certain obstacles up to six feet to the rear. Beeping, with increasing frequency, indicates that Explorer is closing in on the object.







Interior

The interior of the Explorer offers **stylish comfort**

and convenience with incredible versatility. The leather-trimmed

and cloth interiors are both made with exceptional quality

materials. And the **roomy interior** has a large cargo

space versatile enough for all your needs. With **available**

features such as the heated front seats and adjustable

six-way power driver/passenger seat to accommodate most any

size driver, the Explorer takes **driving comfort** to a new level.



Explorer Limited interior shown in Medium Prairie Tan leather trim.



The floor console has controls for the fan blower system as well as handy cupholders.

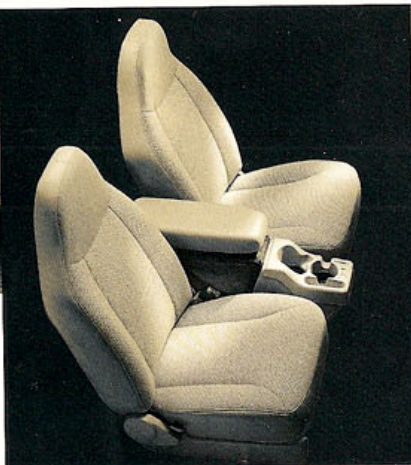

Uniquely styled cloth captain's chairs, available on the XLS, are newly designed and offer superb comfort.



Available 6-disc CD changer provides premium sound.



Available leather-wrapped tilt wheel is adjustable for maximum driver comfort while the auxiliary audio/climate control buttons allow for easier accessibility while driving.



The available overhead console includes reading lamps, an electronic compass, and a convenient outside temperature readout.

Paint Colors



Harvest Gold
Clearcoat Metallic



Autumn Orange
Clearcoat Metallic



Chestnut
Clearcoat Metallic



Bright Red
Clearcoat



Toreador Red
Clearcoat Metallic



Spruce Green
Clearcoat Metallic



Charcoal Green
Clearcoat Metallic



Medium Wedgewood Blue
Clearcoat Metallic



Deep Wedgewood Blue
Clearcoat Metallic



Medium Platinum
Clearcoat Metallic



Tropic Green
Clearcoat Metallic



Black Clearcoat



Oxford White
Clearcoat



White Pearl Tricoat
Clearcoat Metallic

4-Door Models

EXTERIOR PAINT COLORS

INTERIOR TRIM COLORS

	Dark Graphite	Medium Graphite	Medium Prairie Tan
XL (available in cloth only)			
Harvest Gold Clearcoat Metallic			•
Toreador Red Clearcoat Metallic		•	•
Deep Wedgewood Blue Clearcoat Metallic		•	•
Tropic Green Clearcoat Metallic		•	•
Black Clearcoat		•	•
Oxford White Clearcoat		•	•
XLS Group (available in cloth only)			
Harvest Gold Clearcoat Metallic			•
Autumn Orange Clearcoat Metallic		•	•
Bright Red Clearcoat		•	•
Deep Wedgewood Blue Clearcoat Metallic		•	•
Black Clearcoat		•	•
Oxford White Clearcoat		•	•
XLT* (available in leather or cloth)			
Harvest Gold Clearcoat Metallic	•		•
Chestnut Clearcoat Metallic			•
Bright Red Clearcoat	•	•	•
Toreador Red Clearcoat Metallic	•	•	•
Medium Wedgewood Blue Clearcoat Metallic	•		•
Deep Wedgewood Blue Clearcoat Metallic	•	•	•
Medium Platinum Clearcoat Metallic	•		•
Tropic Green Clearcoat Metallic	•	•	•
Black Clearcoat	•	•	•
Oxford White Clearcoat	•	•	•
EDDIE BAUER (available in leather only)			
Chestnut Clearcoat Metallic			•
Toreador Red Clearcoat Metallic	•		•
Spruce Green Clearcoat Metallic	•		•
Medium Wedgewood Blue Clearcoat Metallic			•
Deep Wedgewood Blue Clearcoat Metallic	•		•
Tropic Green Clearcoat Metallic	•		•
Black Clearcoat	•		•
Oxford White Clearcoat	•		•
LIMITED (available in leather only)			
Spruce Green Clearcoat Metallic	•		•
Charcoal Green Clearcoat Metallic	•		•
Deep Wedgewood Blue Clearcoat Metallic	•		•
White Pearl Tricoat Clearcoat Metallic	•		•

2-Door Models

	Dark Graphite	Medium Graphite	Medium Prairie Tan
SPORT (available in leather or cloth)			
Autumn Orange Clearcoat Metallic	•	•	•
Bright Red Clearcoat	•	•	•
Medium Wedgewood Blue Clearcoat Metallic		•	•
Tropic Green Clearcoat Metallic	•	•	•
Black Clearcoat	•	•	•
Oxford White Clearcoat	•	•	•

*XLT available with optional Medium Platinum rocker two-tone paint.

Explorer Wheels



- A** Full face steel wheel
- B** Deep dish cast aluminum wheel
- C** 15" chrome steel wheel
- D** Luxury cast aluminum wheel
- E** 16" polished aluminum wheel
- F** 16" limited cast aluminum wheel

Dealer Accessories



Class III trailer hitch. The ball mount must be purchased separately.



Heavy-duty cargo liner helps protect the rear area and is attached with Velcro™-like fasteners.



Aero hood deflector helps protect the hood from insects, dirt and other debris.



The ski rack comes with a wide range of capacity (up to six pairs of skis or four snowboards). Padded clamp assemblies help guard against damage.
Ford Accessories by Yakima



Rear air deflector is aerodynamically styled and helps keep the rear window free of dirt while adding a stylish touch.



Molded splash guards provide protection against mud, salt and other debris.



The bike rack and removable roof rack accessories allow you to securely fasten the bike for easier and safer transport.
Ford bike rack by Yakima.



Exterior Features

	Sport	XL	XLS Group	XLT	Eddie Bauer	Limited
Tie-die body color with diamond mesh	S	-	S	-	-	S
Fog lamps	-	-	S	S	S	S
Solar tinted glass	S	S	S	S	S	S
Privacy glass in rear quarter, rear door and rear windows	S	-	-	S	S	S
Power flip-out quarter windows	S	-	-	-	-	-
Liftgate with flip-up glass	S	S	S	S	S	S
Luggage rack	S	-	S	S	S	S
Electric remote LH/RH mirrors	S	-	-	S	S	-
Heated electric remote LH/RH mirrors with puddle lamps	-	-	-	-	-	S
Color-keyed bodyside moldings	S	-	S	S	S	S
Wheelie moldings	0	-	S	-	S	S
Running boards (illuminated on Eddie Bauer/Limited)	-	-	-	0	S	S
High-mount stop lamp (rear)	S	S	S	S	S	S
Wipers, speed-sensitive, dual, intermittent	S	-	S	S	S	S
Rear intermittent wiper/washer/defroster	S	S	S	S	S	S
Side step bars (included w/optional Premium Sport Group)	0	-	S	-	-	-
Keyless entry pad	-	-	-	S	S	S
Tape stripes	-	-	-	S	-	S

Interior Features

Air conditioning, manual	S	S	S	S	-	-
Air conditioning/electronic automatic temperature control	-	-	-	-	S	S
Cargo area retractable cover	-	-	-	-	S	S
Color-keyed carpeting	S	S	S	S	S	-
Deluxe full length, color-keyed carpeting	-	-	-	-	-	S
Floor console (unique high series) with dual cupholders, ashtray, armrest, rear audio and rear heater/AC controls	-	-	-	-	S	S
Removable storage bag	-	-	S	-	-	-
Reversible cargo mat	-	-	-	S	S	S
Illuminated entry	S	S	S	S	S	S
Instrument panel with four gauge cluster with warning lights, trip odometer and tachometer	S	S	S	S	S	S
Power lock/unlock liftgate button	S	-	S	S	S	S
Message center with fuel, oil life, and warning messages	-	-	-	-	S	S
Heated leather rearview mirror with autolamp	-	-	-	0	S	S
Power Equipment Group with power windows/door locks, illuminated controls, "one-touch-down" feature for driver's window, electric mirrors, accessory delay, two-step unlocking system with interior lock/unlock button in cargo area	S	-	S	S	S	S
Front overhead console with deluxe front map/reading lamps, compass and outside temperature. Includes rear reading lamps	-	-	-	-	S	S
Powerpoint (12 volt)	S	S	S	S	S	S
Speed control with tilt steering	-	-	-	-	S	S
Black leather wrapped steering wheel	-	-	-	-	S	-
Color-keyed leather wrapped steering wheel with auxiliary audio, climate and speed controls	-	-	-	-	S	S
Illuminated LH/RH visor vanity mirrors	-	-	-	-	S	S
Handlink System with Travebot	-	-	-	0	S	S

S = Standard 0 = Optional I = Included A = Additional equipment at no charge

Engines

	Sport	XL	XLS Group	XLT	Eddie Bauer	Limited
4.0L OHV/SEFI 5-speed manual 0/D	S	S	S	-	-	-
4.0L OHV/SEFI 5-speed automatic 0/D Sport (only with Comfort Group)	A	0	0	A	-	-
4.0L SOHC/SEFI 5-speed automatic 0/D (XL, XLS available fleet only)	0	-	-	0	S	S
5.0L OHV/SEFI 4-speed automatic 0/D	-	-	-	0	0	0

Seating Arrangements

Cloth captain's chairs with floor console	S	0	-	-	-	-
Unique cloth captain's chairs with floor console	-	-	S	-	-	-
Cloth sport buckets (requires side airbags)	-	0	0	-	-	-
Cloth sport buckets with 6-way power driver's seat, manual driver/passenger lumbar support (without floor console)	0	-	-	S	-	-
Cloth 60/40 split bench seat with storage bin (fleet only)	-	0	-	0	-	-
Sport buckets with leather seating surfaces, 6-way power driver/passenger seat (power driver only on Sport), manual driver/passenger lumbar adjustment	0	-	-	0	A	-
Luxury buckets with leather seating surfaces, 6-way power driver/passenger seat, power driver/passenger lumbar support and 3-position driver's memory seat	-	-	-	-	-	A
Vinyl bucket seats (fleet only)	-	S	-	-	-	-
Heated front seats	-	-	-	-	0	S

Audio

AM/FM stereo/cassette	S	S	-	-	-	-
AM/FM stereo/single CD (24 watt)	-	0	S	S	-	-
Premium AM/FM stereo/cassette single CD/Premium Sound (80 watt)	0	0	0	0	-	-
MACH™ Audio System with stereo/cassette/single CD	0	-	-	0	A	A
6-disc CD changer	0	-	-	0	0	0

Safety/Security

Second Generation Depowered driver and front passenger airbag supplemental restraint system	S	S	S	S	S	S
Front side airbags	0	0	0	0	0	0
Adjustable-height outboard safety belts	S	S	S	S	S	S
Illuminated entry system	S	S	S	S	S	S
SecuriLock™ passive anti-theft system	S	S	S	S	S	S
Childproof rear door locks	-	S	S	S	S	S
Side door intrusion beams	S	S	S	S	S	S
Keyless entry pad	-	-	-	S	S	S
Remote Keyless entry (with two key fobs)	0	0	0	S	S	S
4-wheel ABS	S	S	S	S	S	S

Available Option Groups

Convenience Group includes cargo cover remote keyless entry, speed control/tilt steering wheel, floor mats (2 door only), privacy glass (4 door only)	0	0	0	I	I	I
Comfort Group includes cloth sport bucket seats with power driver seat, keypad/autolock/anti-theft, Dual Media radio, high series floor console, electrochromic mirror/autolamp, puddle lamps, overhead console (requires Convenience Group)	0	-	-	-	-	-
Premium Sport Group includes platinum wheelie moldings, fog lamps, platinum front and rear bumpers, side step bars, 15" chrome stud (4x2) or 16" cast aluminum wheels (4x4), P235-OWL A-T tires (4x2), P235-OWL A-T tires (4x4) rear tow hook and Dual Media radio (requires Convenience Group)	0	-	-	-	-	-

Available Option Groups Cont.

	Sport	XL	XLS Group	XLT	Eddie Bauer	Limited
XL Appearance Group includes cloth captain's chairs, power windows, locks, mirrors, rear window wiper/washer, defroster, luggage rack, P235/75-X/5 OWL A-T tires, deep-dish aluminum wheels and color-keyed B/S moldings (required with XLS Group)	-	0	-	-	-	-
XLS Group includes unique cloth captain's chairs, side step bar, wheelie moldings, fog lamps, color-keyed bodyside molding, AM/FM stereo/clock/cassette/CD, removable storage bag and 15" chrome steel wheels (requires XL Appearance Group)	-	0	-	-	-	-

Wheels

Deep-dish cast aluminum (4)	S	0	-	0	-	-
15" chrome steel (4)	-	-	S	-	-	-
Luxury cast aluminum (4)	-	-	-	S	-	-
16" cast aluminum (4)	-	-	-	-	S	-
16" Limited cast aluminum (4)	-	-	-	-	-	S
Full face steel (4)	-	S	-	-	-	-

Note: spare wheels are steel and 4 tires with matching spare.

Miscellaneous Options

Power moonroof	0	-	-	0	0	0
Reverse Sensing System	0	-	-	0	0	0
Rear load leveling (4x4 and AWD only)	-	-	-	0	0	0
Trailer Tow Prep Package	0	0	0	0	0	0
Engine block heater	0	0	0	0	0	0
License plate bracket	0	0	0	0	0	0
Rocker two-tone paint	-	-	-	0	-	-
Side step bar	0	-	-	-	-	-
Electrochromic mirror with autolamp	-	-	-	0	S	S
Running boards	-	-	-	0	-	-
Skid plate package (4x4/AWD only)	0	0	0	0	0	0

Specifications

Drivetrain:	4x2 or 4x4
Engine type:	4.0-liter OHV V6; optional 4.0-liter SOHC V6 standard with Eddie Bauer and Limited and 5.0-liter OHV V8
Induction system:	Multi-port electronic fuel injection with EEC-V computer
Transmissions:	Std. 5-speed manual OD; opt. 5-speed automatic OD (SOHC V6), standard with Eddie Bauer and Limited; opt. 4-speed automatic OD (V8)
Battery:	72 AH; 650 CCA maintenance-free with battery saver
Alternator:	95 amps
Security:	SecuriLock passive anti-theft system
Frame:	Ladder-type, single channel with six crossmembers
Front suspension:	Independent SLA, torsion bar (computer-selected), gas-pressurized shock absorbers, stabilizer bar
Rear suspension:	Semi-floating-type rear axle (limited-slip differential optional), 2-stage variable-rate leaf springs (computer-selected), gas-pressurized shock absorbers, stabilizer bar
Rear load-leveling system (optional):	Adjustable air shock absorber leveling system (optional only with XLT, Eddie Bauer and Limited 4x4 and AWD models)
Steering:	Power-assisted rack-and-pinion, 17:1 ratio
Brakes:	4-wheel power disc with 4-wheel anti-lock system
Fuel tank:	17.5 gallons (2-door); 21 gallons (4-door)
Wheels (type/size):	5-hole disc/15"x7.0 (16" cast aluminum with Eddie Bauer/Premium Sport Group (4x4) 15" chrome steel w/Premium Sport Group (4x2) 16" unique aluminum with Limited, cast aluminum deep dish with Sport, full-face steel with XL, luxury aluminum with XLT
Tires:	P225/70R15SL all-season (XL) available with Limited, P235/75R15SL OWL all-terrain (Sport, XLS, XLT) P255/70R16 OWL all-terrain (Eddie Bauer, Limited) Premium Sport Group includes: P235/75R15SL OWL all-terrain (4x2), P255/70R16 OWL all-terrain (4x4)

Dimensions	2 Door 4x2	2 Door 4x4	4 Door 4x2	4 Door 4x4
Angle of approach - loaded	26°	26°	26.3°	26.3°
Angle of departure - unloaded	17.6°	17.6°	18.0°	18.0°
Axle clearance - unloaded (rear)	6.7"	6.7"	6.7"	6.7"
Cargo length with rear seat up @ belt with rear seat down @ belt	30.7" 61.5"	30.7" 61.5"	38.7" 71.4"	38.7" 71.4"
Cargo volume (cu. ft.) with rear seat up with rear seat down	34.4 69.7	34.4 69.7	43.5 81.0	43.5 81.0
Front/rear head room	39.9"/39.3"	39.9"/39.3"	39.9"/39.3"	39.9"/39.3"
Shoulder room	56.7"/58.0"	56.7"/58.0"	56.7"/56.8"	56.7"/56.8"
Hip room	51.9"/43.6"	51.9"/43.6"	51.9"	51.9"
Leg room	42.4"/34.5"	42.4"/34.5"	42.4"/36.8"	42.4"/36.8"
Trunk opening height	33.7"	33.7"	33.7"	33.7"
Load floor height (empty)	28.1"	27.8"	29.1"	28.9"
Overall height (empty - max.)	67.1"	67.0"	67.7"	67.5"
Overall length	180.8"	180.8"	190.7"	190.7"
Overall width	70.2"	70.2"	70.2"	70.2"
Overhang (front/rear)	33.9"/44.0"	33.9"/44.0"	33.9"/44.0"	33.9"/44.0"
Ramp breakover angle - loaded	17.9°	17.9°	16.4°	16.4°
Seating capacity	4	4	5 or 6*	5 or 6*
Step in height (unloaded)	19.8"	19.8"	20.1"	20.0"
Tread (front/rear)	58.5"/58.5"	58.5"/58.5"	58.5"/58.5"	58.5"/58.5"
Wheelbase	101.7"	101.7"	111.6"	111.6"
Width between wheelhouses	41.9"	41.9"	41.9"	41.9"

*Six-passenger seating with optional split bench front seat in XL and XLT.

Maximum Trailer Towing Weights (lbs.)	Axle Ratio	Maximum GCWR	2-Door		4-Door	
			4x2	4x4	4x2	4x4
5.0L OHV V8/4-spd. auto. OD	3.73	11,000	-	-	6,740	6,520
4.0L SOHC V6/5-spd. auto. OD	3.27	7,500	3,000	3,380	-	-
	3.55	8,500	4,500	4,380	-	-
		9,000	-	-	4,500	4,500
	3.73	9,000	5,100	4,880	-	-
		10,000	-	-	5,900	5,680
4.0L OHV V6/5-spd. auto. OD	4.10	9,000	-	4,880	-	-
		10,000	-	-	5,900	5,680
	3.73	9,000	5,120	4,900	4,920	4,680
4.0L OHV V6/5-spd. man. OD	4.10	9,000	-	4,900	-	-
	3.27	6,000	2,000	1,940	1,960	-
	3.55	6,500	-	2,440	-	2,220
	3.73	7,000	3,160	2,940	2,960	2,720

NOTE: Engine/axle ratio combinations shown may not be available in all areas. Your Ford Dealer can supply availability information. All maximum trailer weights shown must be reduced by passenger and cargo weight in the towing vehicle. The following equipment may be required: load-carrying hitch for towing trailers under 3,500 pounds with the standard rear step bumper; load-equalizing hitch for towing trailers over 3,500 pounds. For specific information on recommended or required equipment, see your dealer.

Competitive comparisons based on published 1998 competitive data.

Powertrain/Drivetrain Combinations by Series/Package

	XL	XLT	Eddie Bauer	Limited	Sport
4.0L Powerteam - OHV/SEFI V6	5-spd. man. OD	5-spd. man. OD	-	-	5-spd. man. OD
4.0L Powerteam - OHV/SEFI V6	5-spd. auto. OD	5-spd. auto. OD	-	-	5-spd. auto. OD
4.0L Powerteam - SOHC/SEFI V6	-	5-spd. auto. OD	5-spd. auto. OD	5-spd. auto. OD	5-spd. auto. OD
5.0L Powerteam - OHV/SEFI V8	-	4-spd. auto. OD	4-spd. auto. OD	4-spd. auto. OD	-
Drivetrain - V6	4x2 or Control-Trac w/4.0L	4x2 or Control-Trac w/4.0L	4x2 or Control-Trac w/4.0L	4x2 or Control-Trac w/4.0L	-
Drivetrain - V8	-	4x2 or AWD w/5.0L	4x2 or AWD w/5.0L	4x2 or AWD w/5.0L	4x2 or Control-Trac

Engine Specifications

Engine	Displacement (liters/cubic inches)	Bore x Stroke	Compression Ratio	Horsepower (SAE net)	Torque, lbs./ft. (SAE net)
4.0L OHV V6	4.0/245	3.95 x 3.32	9.0:1	160 @ 4,200 rpm	225 @ 2,750 rpm
4.0L SOHC V6	4.0/245	3.95 x 3.32	9.7:1	210 @ 5,250 rpm	240 @ 3,250 rpm
5.0L OHV V8	5.0/302	4.00 x 3.00	9.05:1	215 @ 4,200 rpm	288 @ 3,300 rpm

"Tread Lightly" is an educational program designed to increase the awareness of land-use regulations and responsibilities in our wilderness areas. Ford joins the U.S. Forest Service and the Bureau of Land Management in encouraging you to preserve our national forests and other public and private lands by "treading lightly."

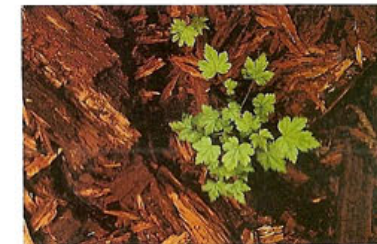

Product Changes and Options Availability: Following publication of the catalog, certain changes in standard equipment, options, prices and the like, or product delays, may have occurred which would not be included in these pages. Your Ford Dealer is your best source for up-to-date information. Ford Division reserves the right to change product specifications at any time without incurring obligations. Options shown or described are available at extra cost and may be offered only in combination with other options or subject to additional ordering requirements or limitations.

Roadside Assistance: Every new Ford includes the assurance of a 24-hour emergency Roadside Assistance Program provided during the 3-year/36,000-mile bumper-to-bumper warranty. Ask your Ford Dealer for a copy of the limited warranty and complete details on this program which includes such services as fuel delivery, tire change, jump start, or even help when you're locked out of your vehicle.



Race For The Cure: As part of our ongoing commitment to breast cancer research and public awareness, Ford Division is proud to continue its national sponsorship of the Susan G. Komen Foundation's Race For The Cure.





Visit the Ford website at www.ford.com